

Eine Ideensammlung mit technischen Details von ausgeführten Projekten.

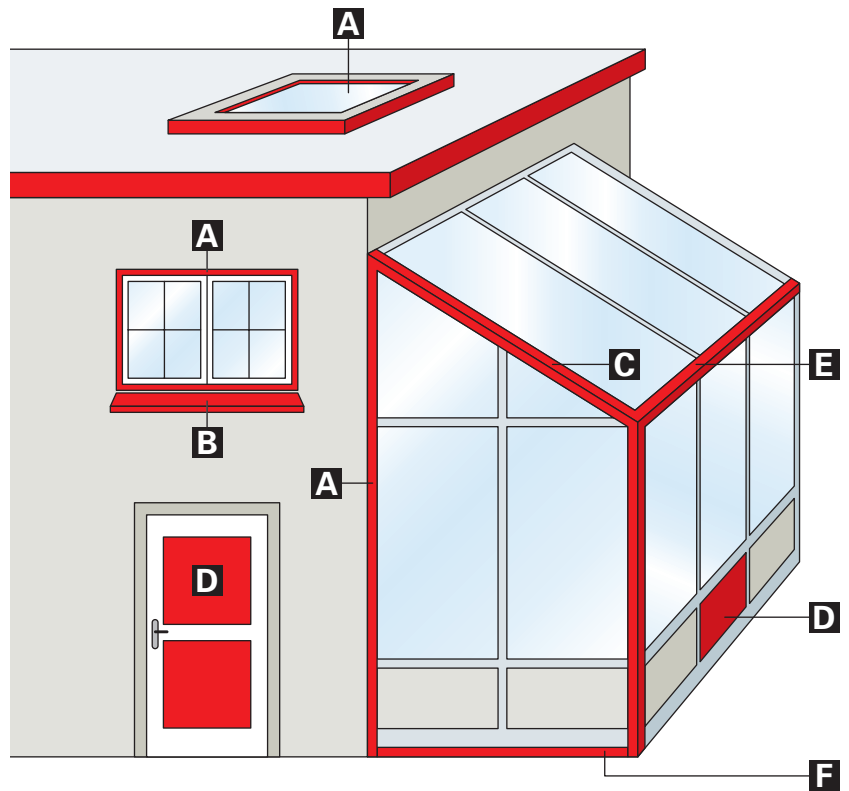

	Seite
A Wandanschlüsse	
A¹ Spezialverglasung	4.01
A² Metallbau	4.02
A³ Flachdach	4.05
B Fensterbankisolation	4.10
C Eckdetails	4.11
D Sandwichbau	4.18
E Schrägverglasungen	4.19
F Fusspunkte	4.26
G Diverses	4.33

Sturzdetail Spezialverglasung

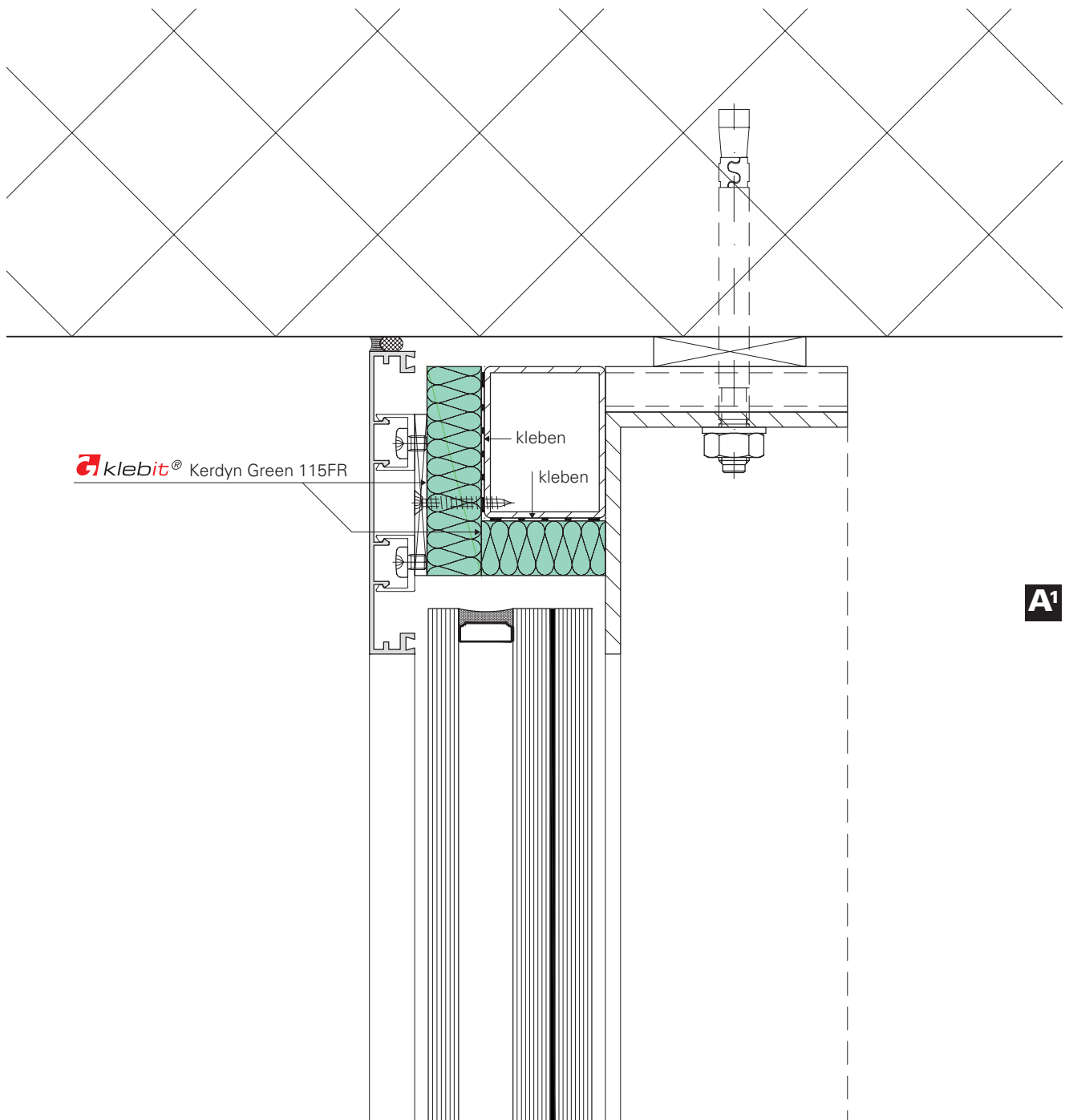

Detail Wandanschluss

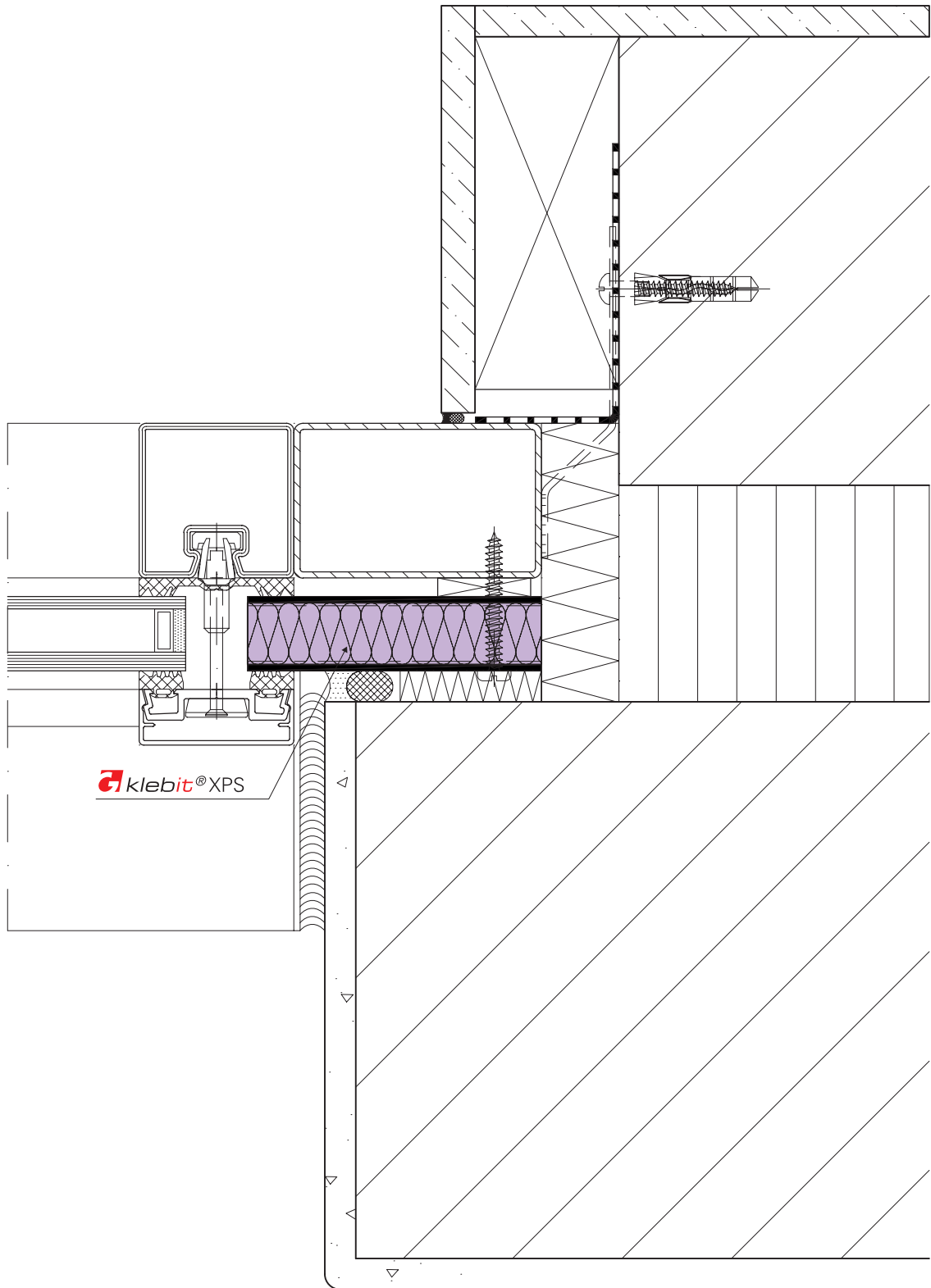

Detail Wandanschluss Dachverglasung

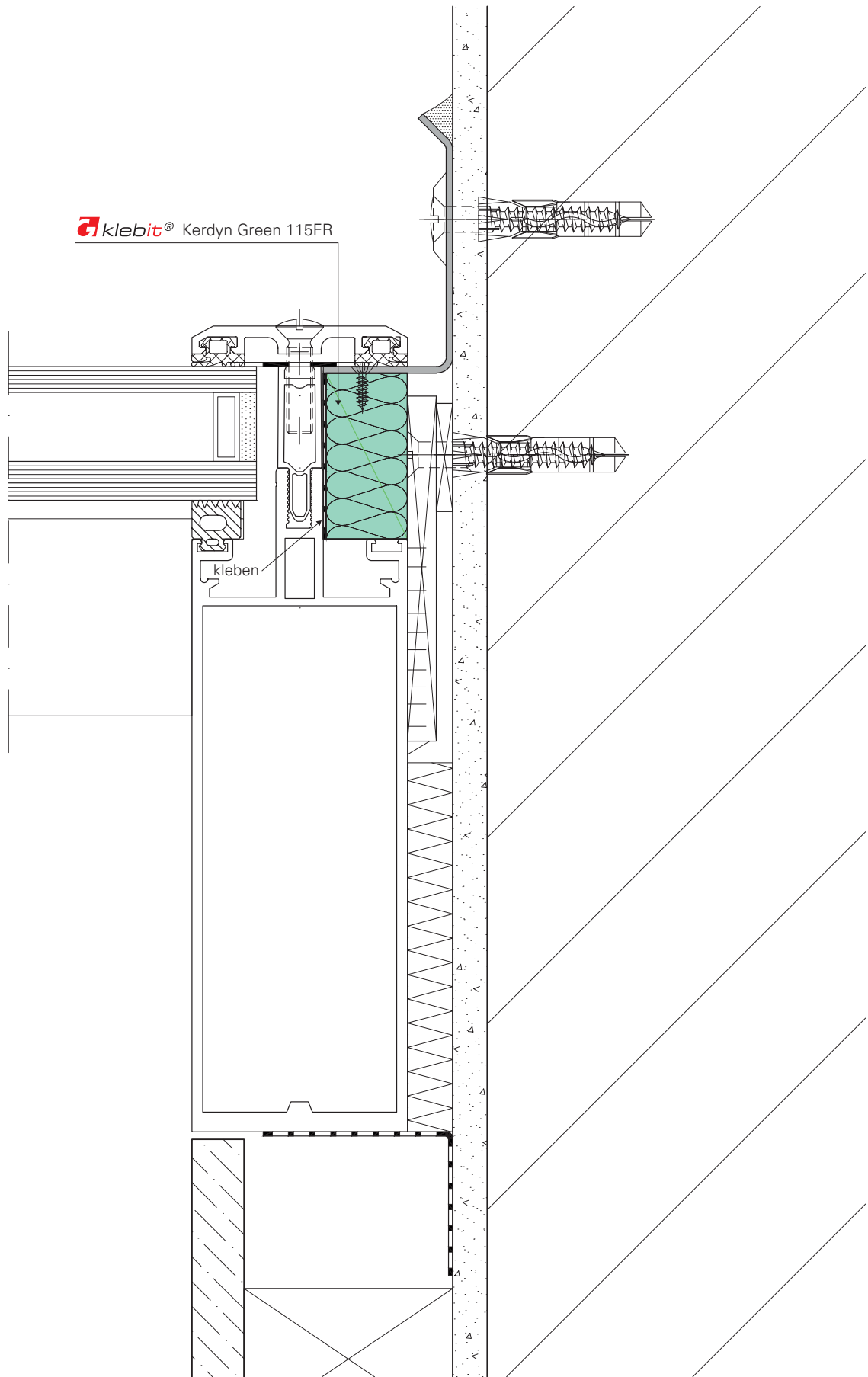

A²



Detail Wandanschluss Fassade

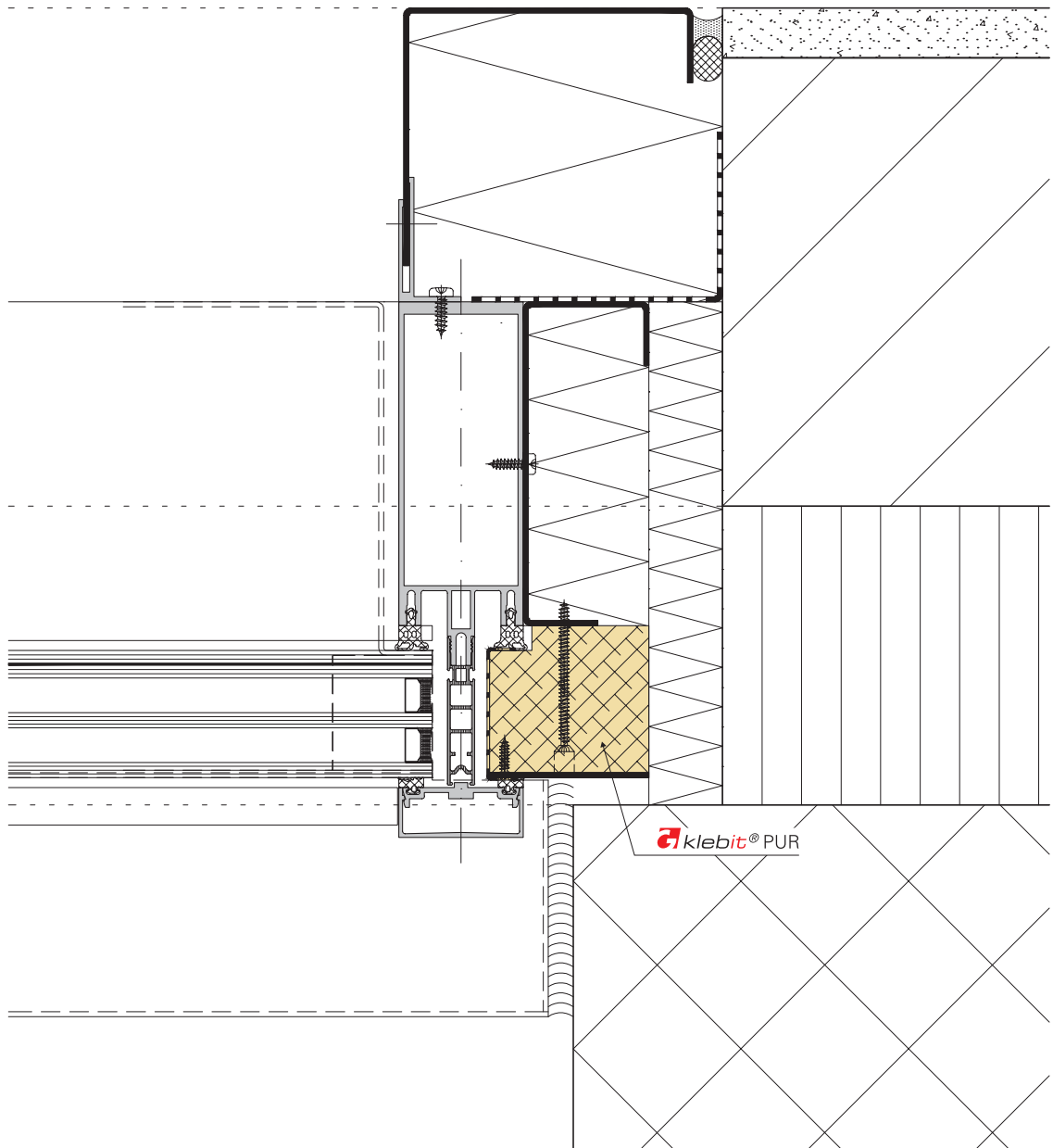

A²



Detail Dachrand Windfang

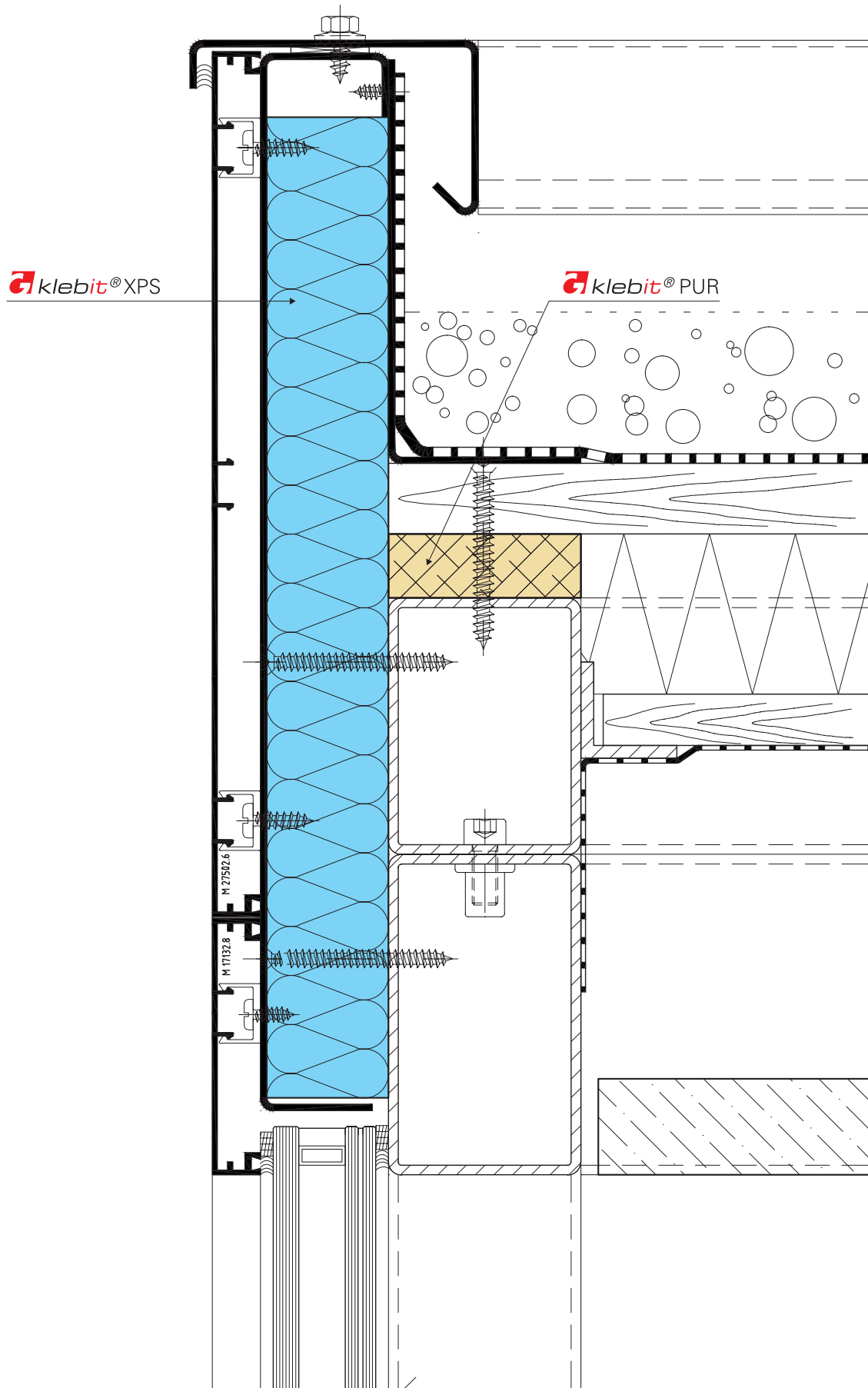

Anschlussdetail begehbares Oberlicht

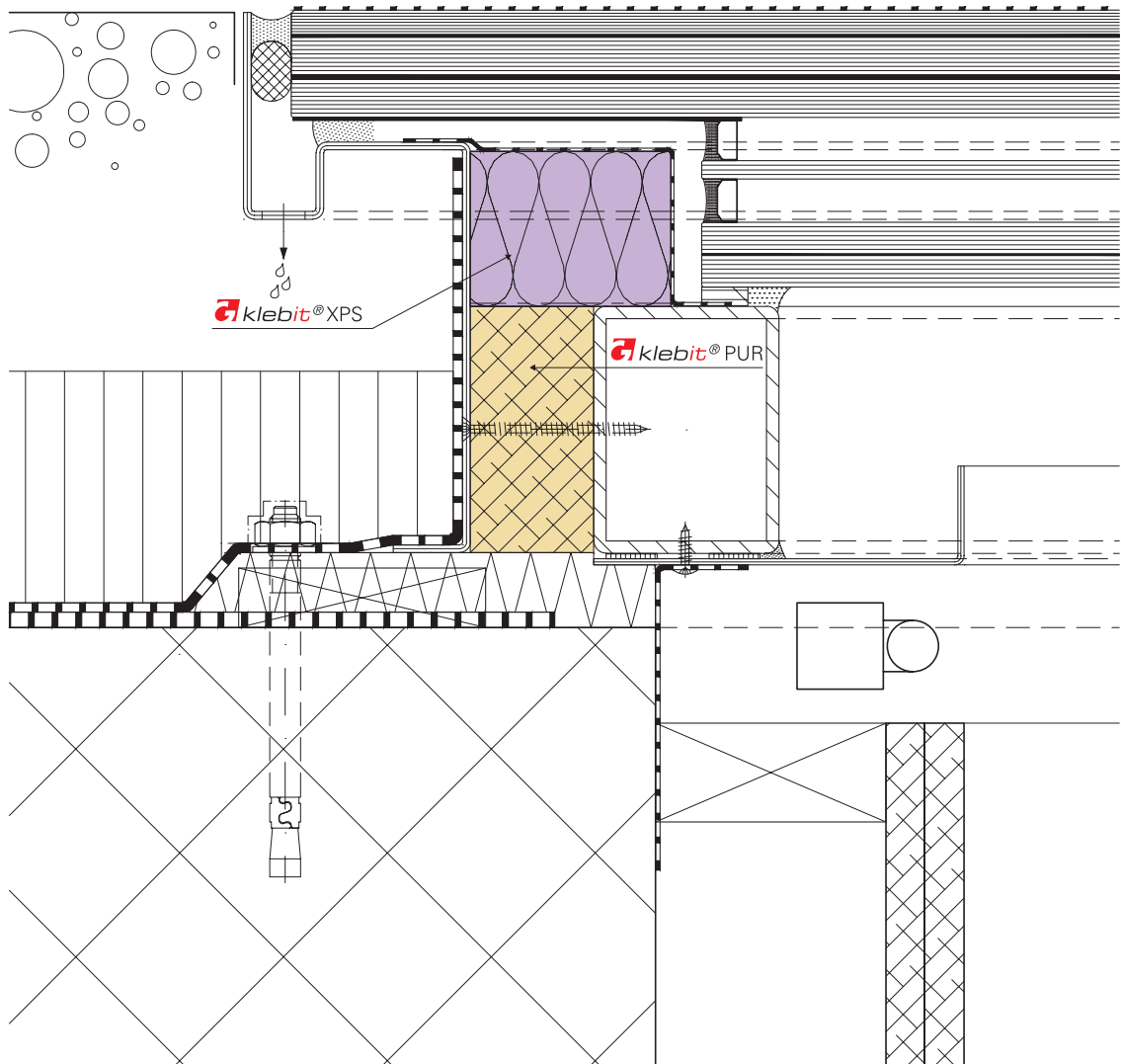

A³

Anschlussdetail Glasdach

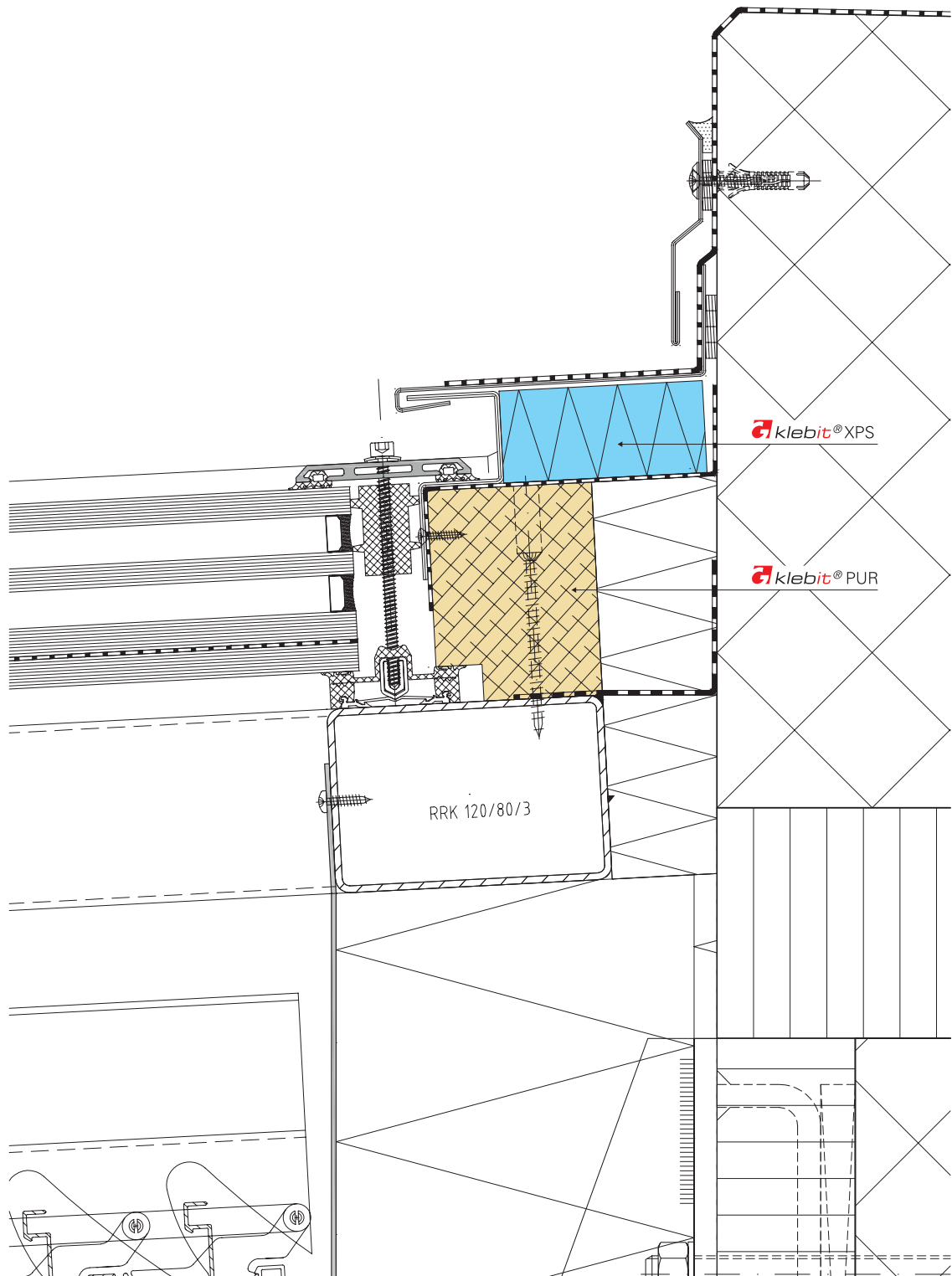

A3

Anschlussdetail Glastach (Rinne)

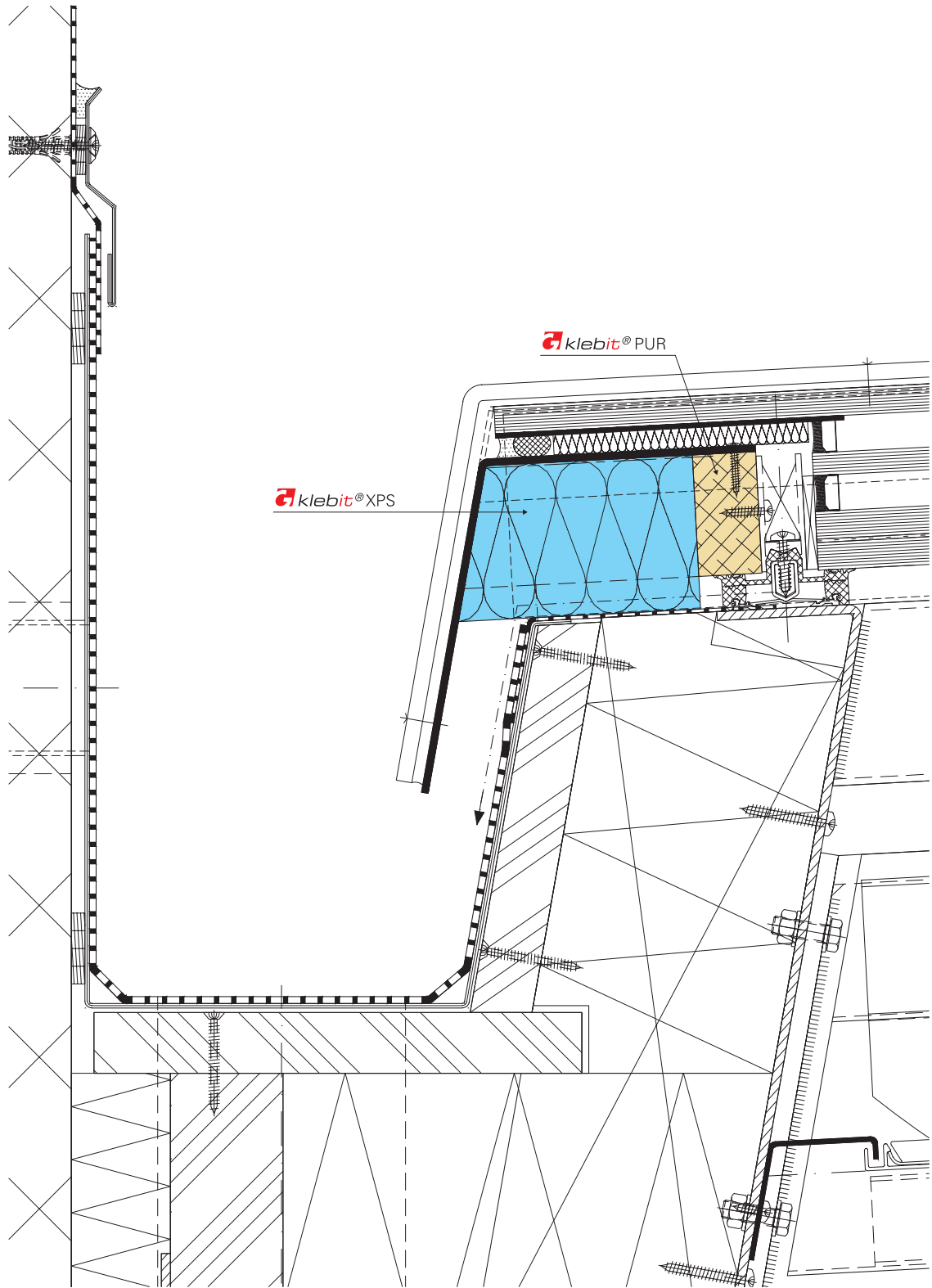

A³

Detail Dachrand Flachdach

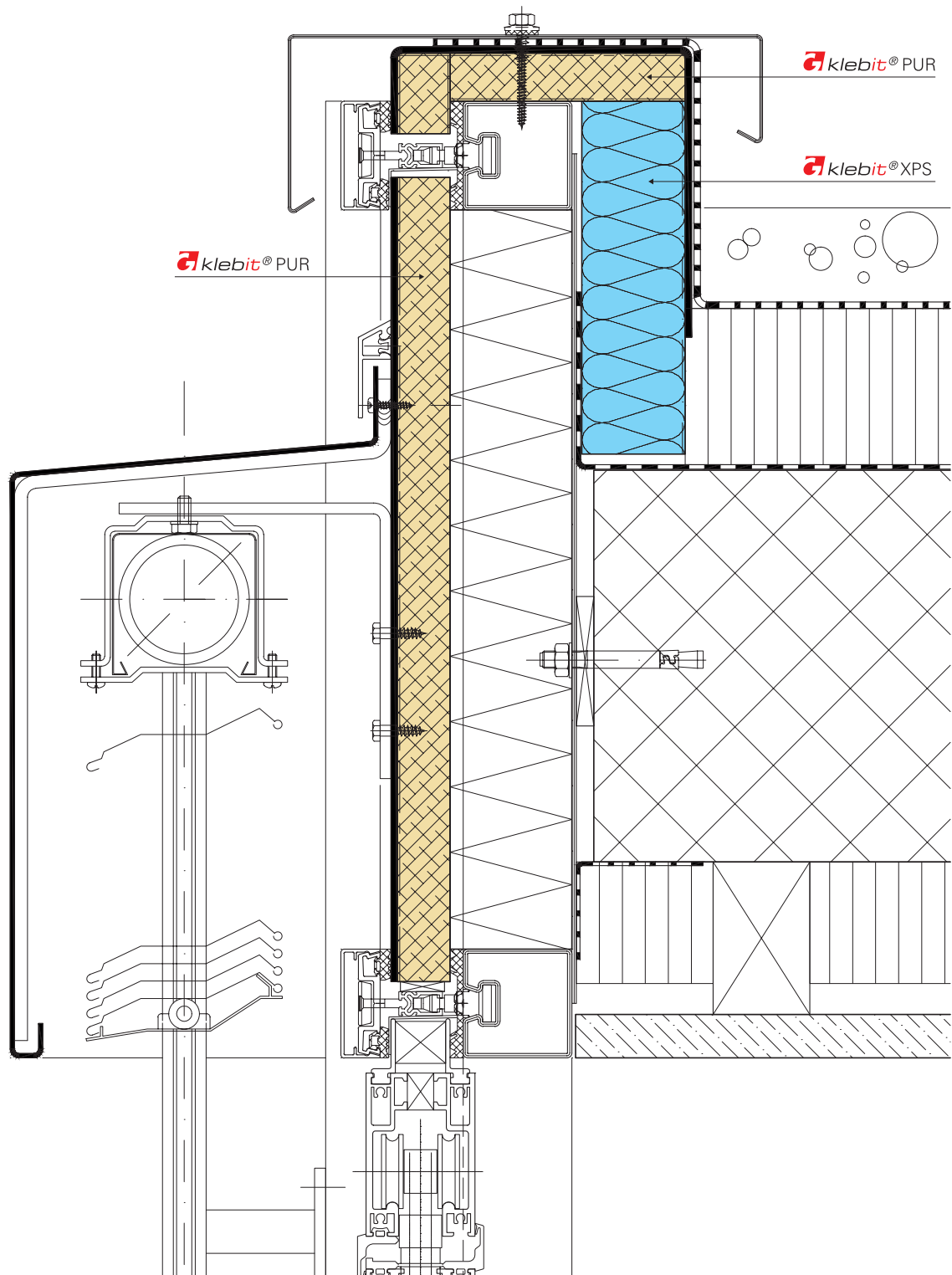

A³

Detail Fensterbank

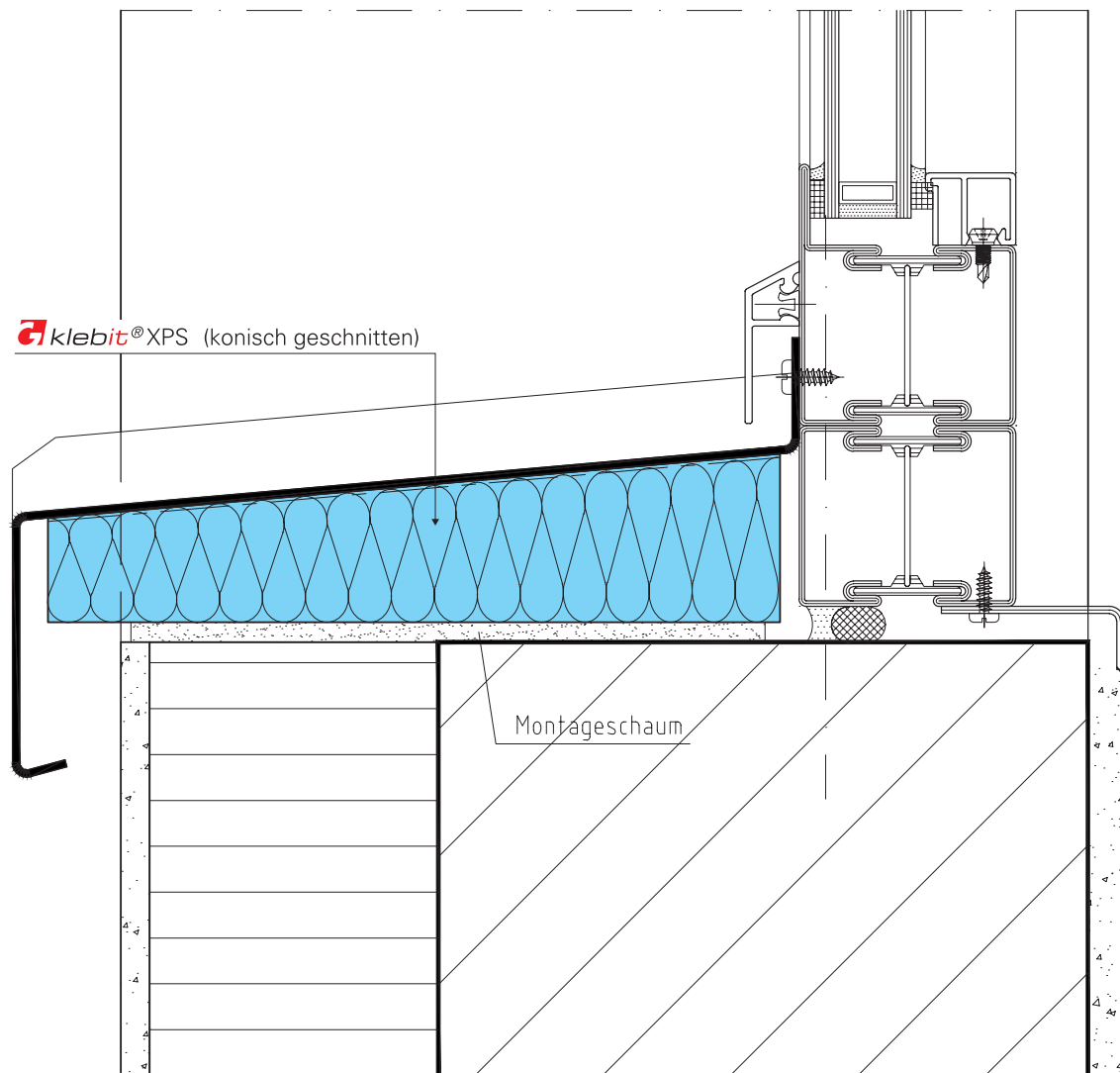

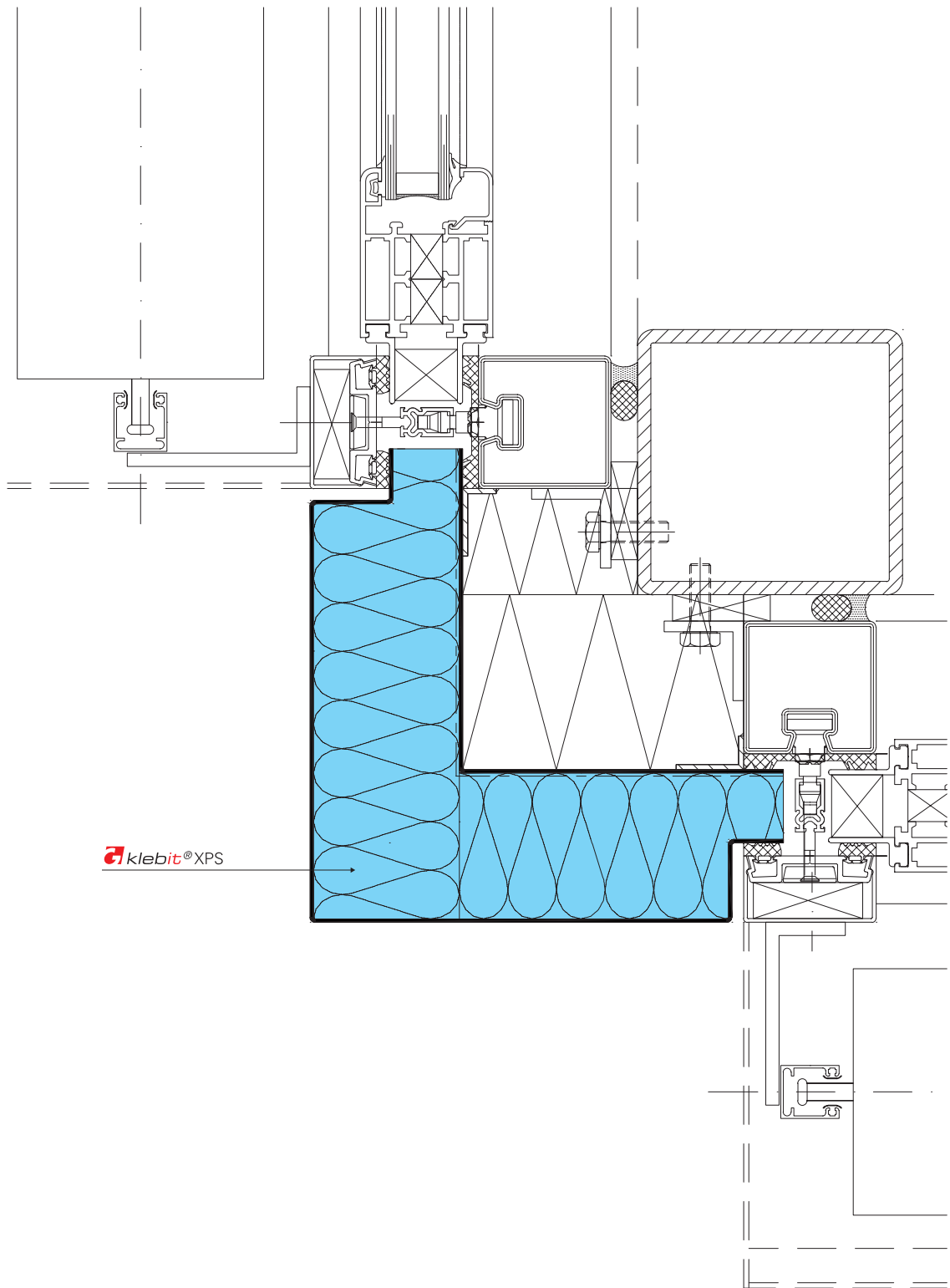

 klebit® XPS

C

Fassadenecke

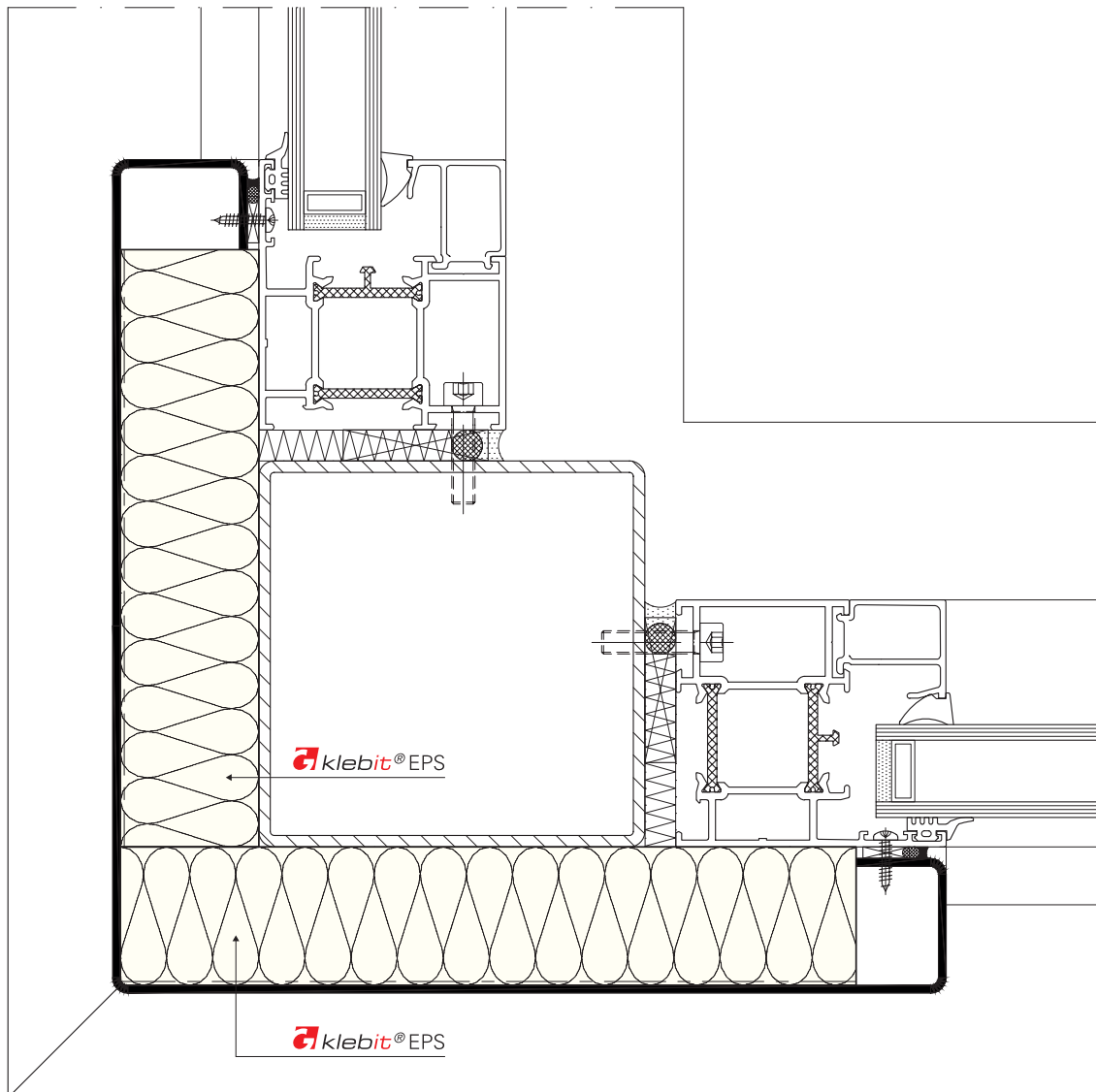

C

Detail Dachbereich

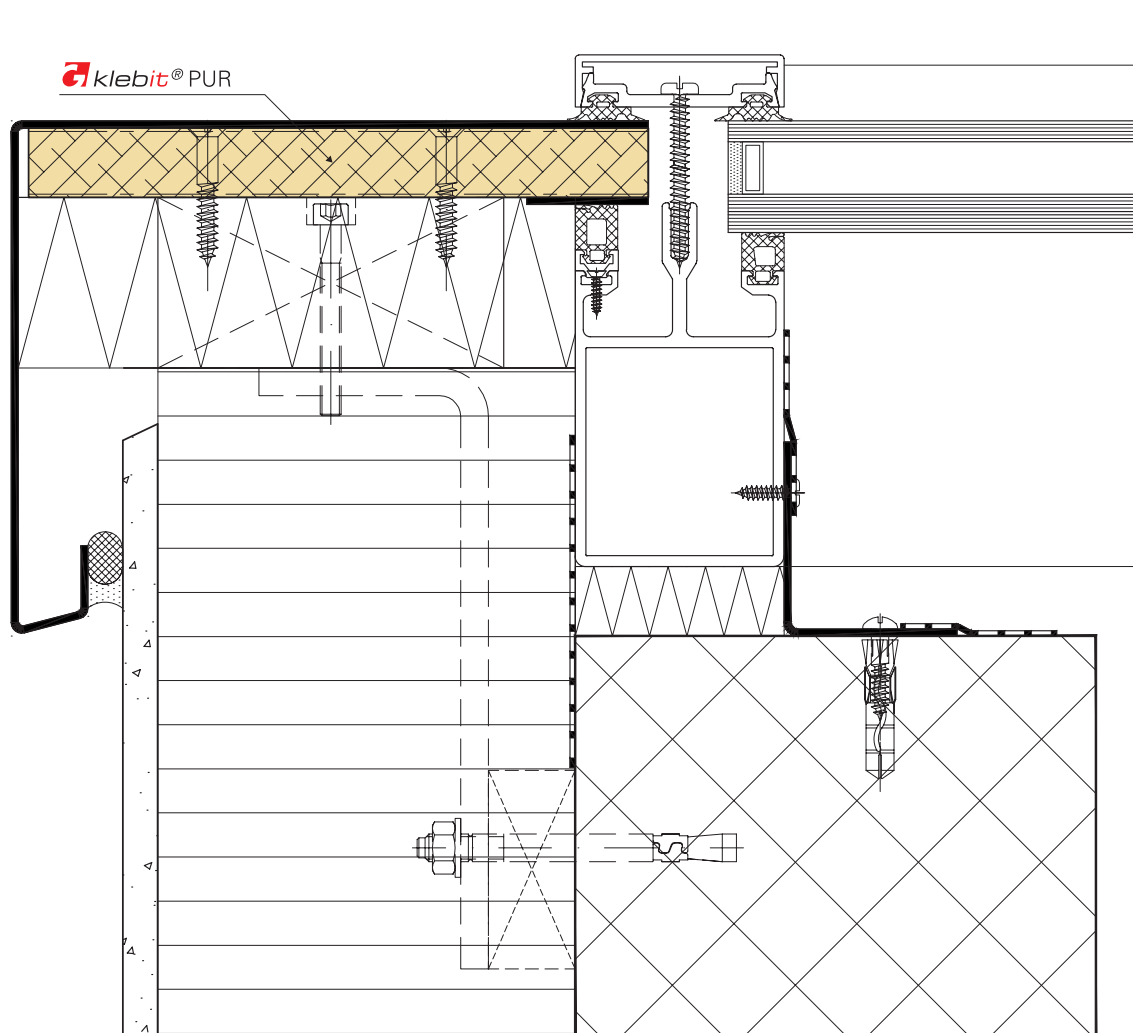

C



Fassadenecke 135°

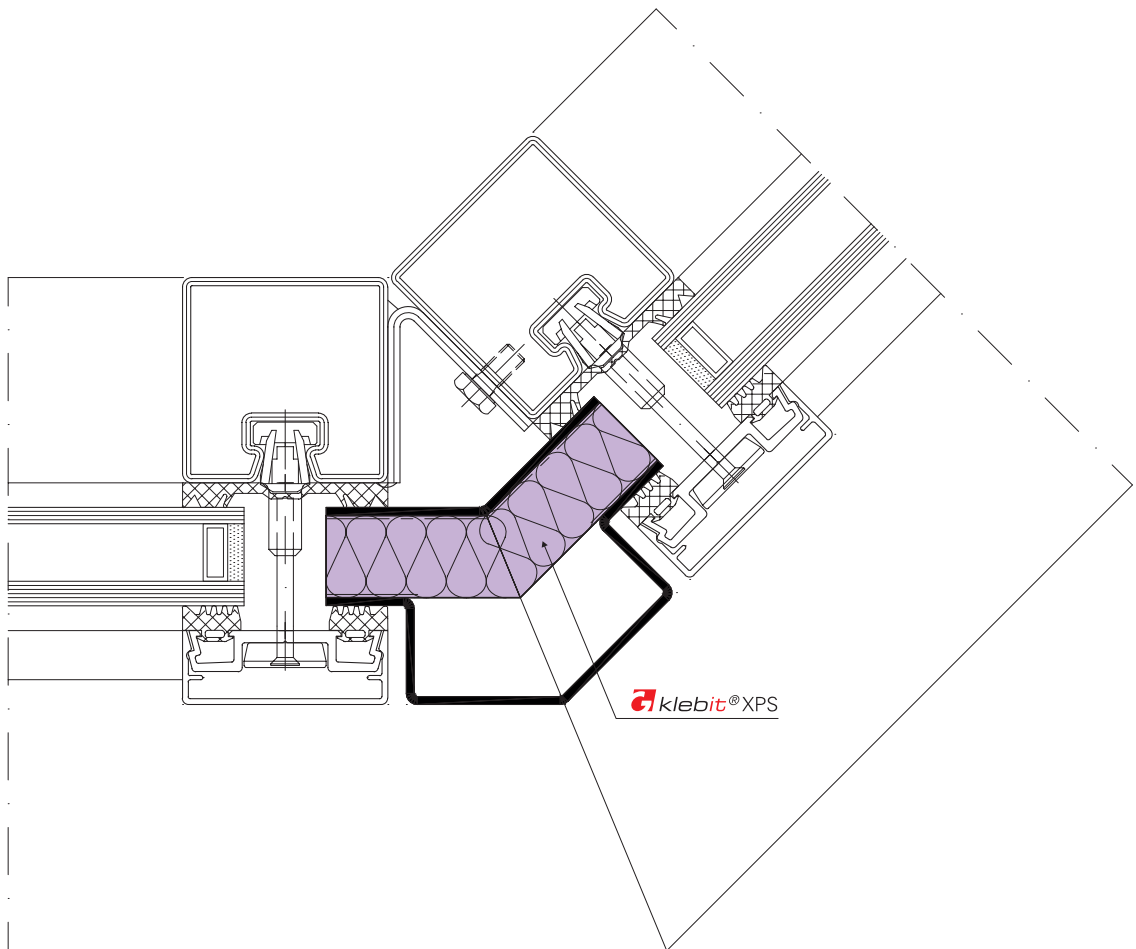

C

Detail Fassadenecke

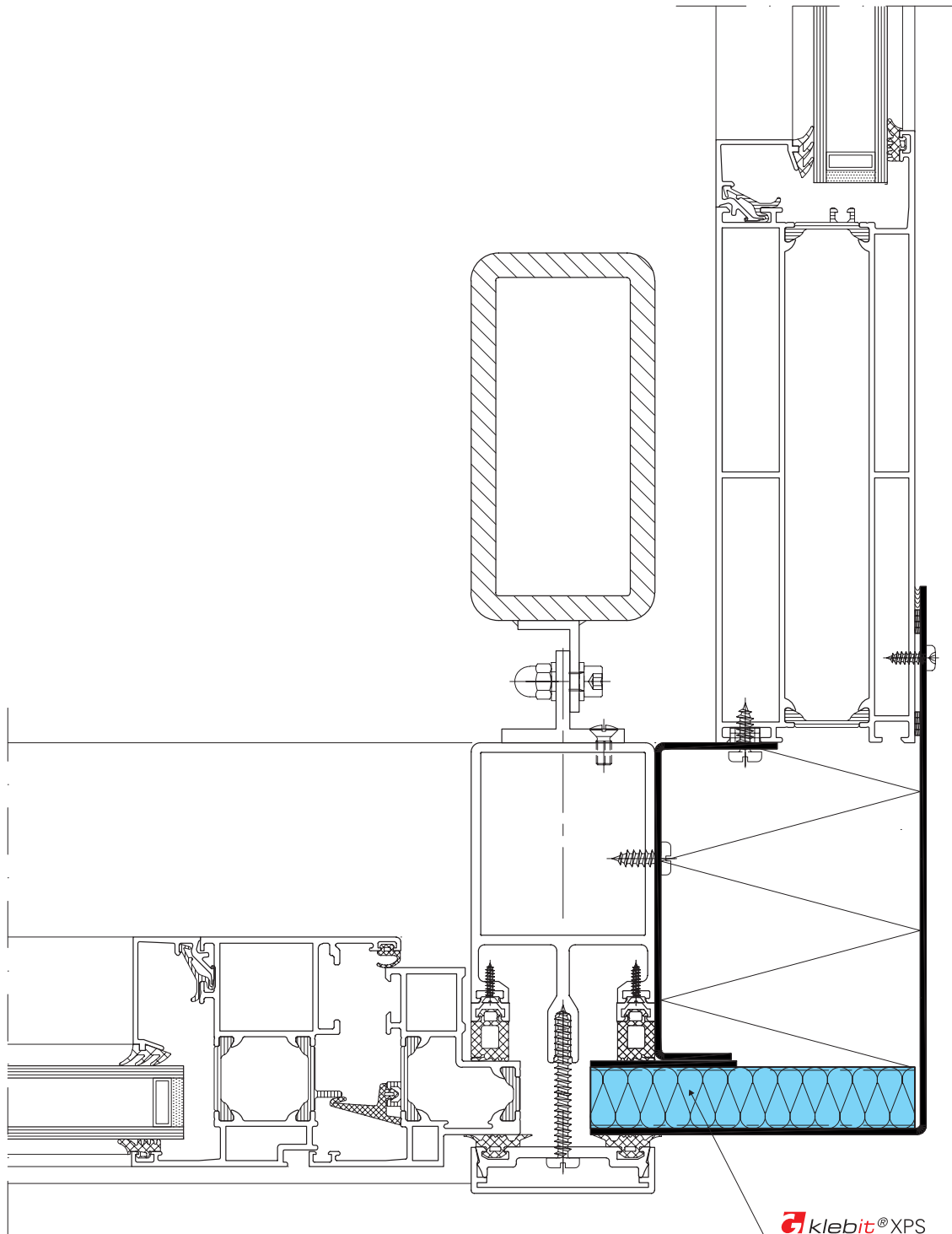

C



Eckdetail 90°

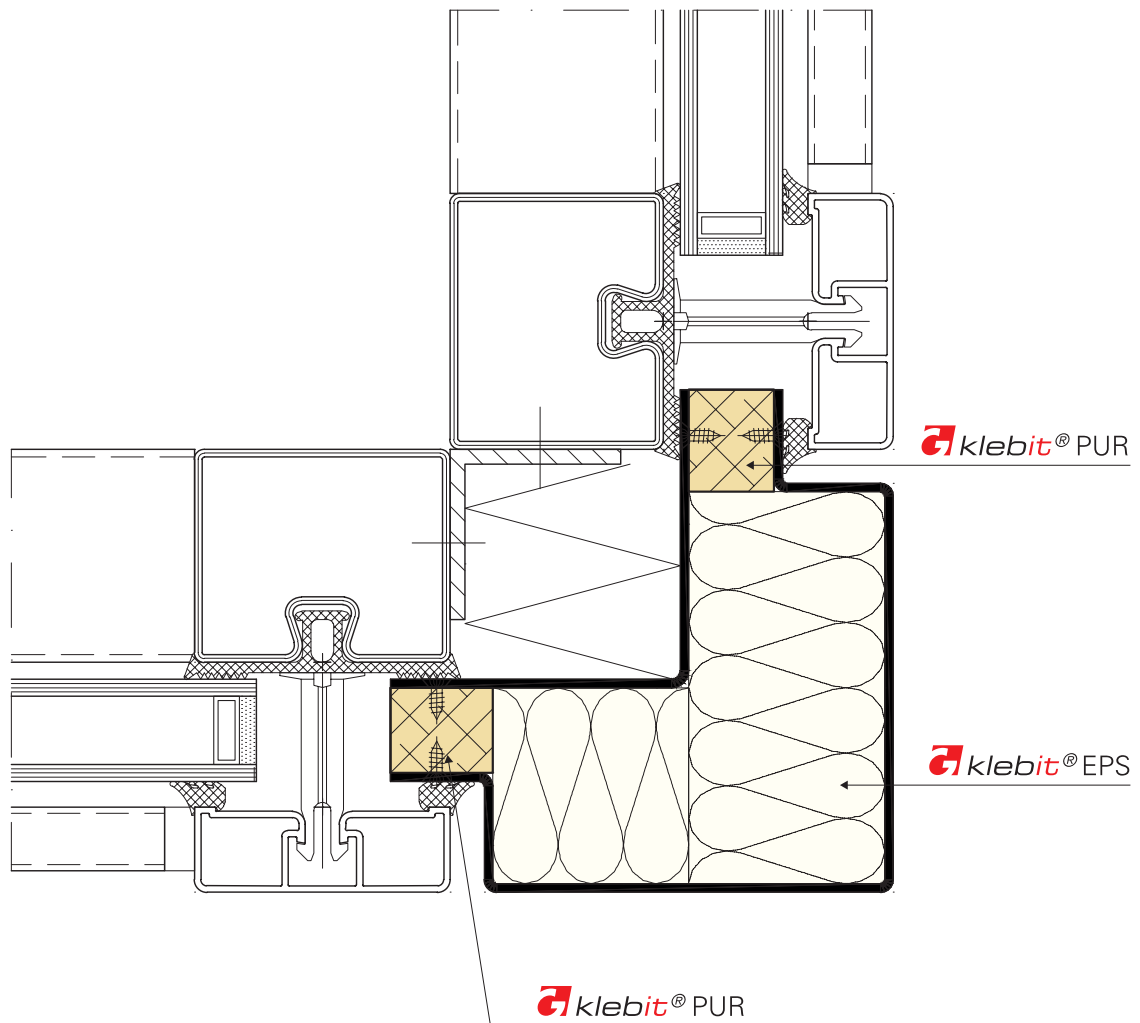

Eckdetail Dachrand Glasdach

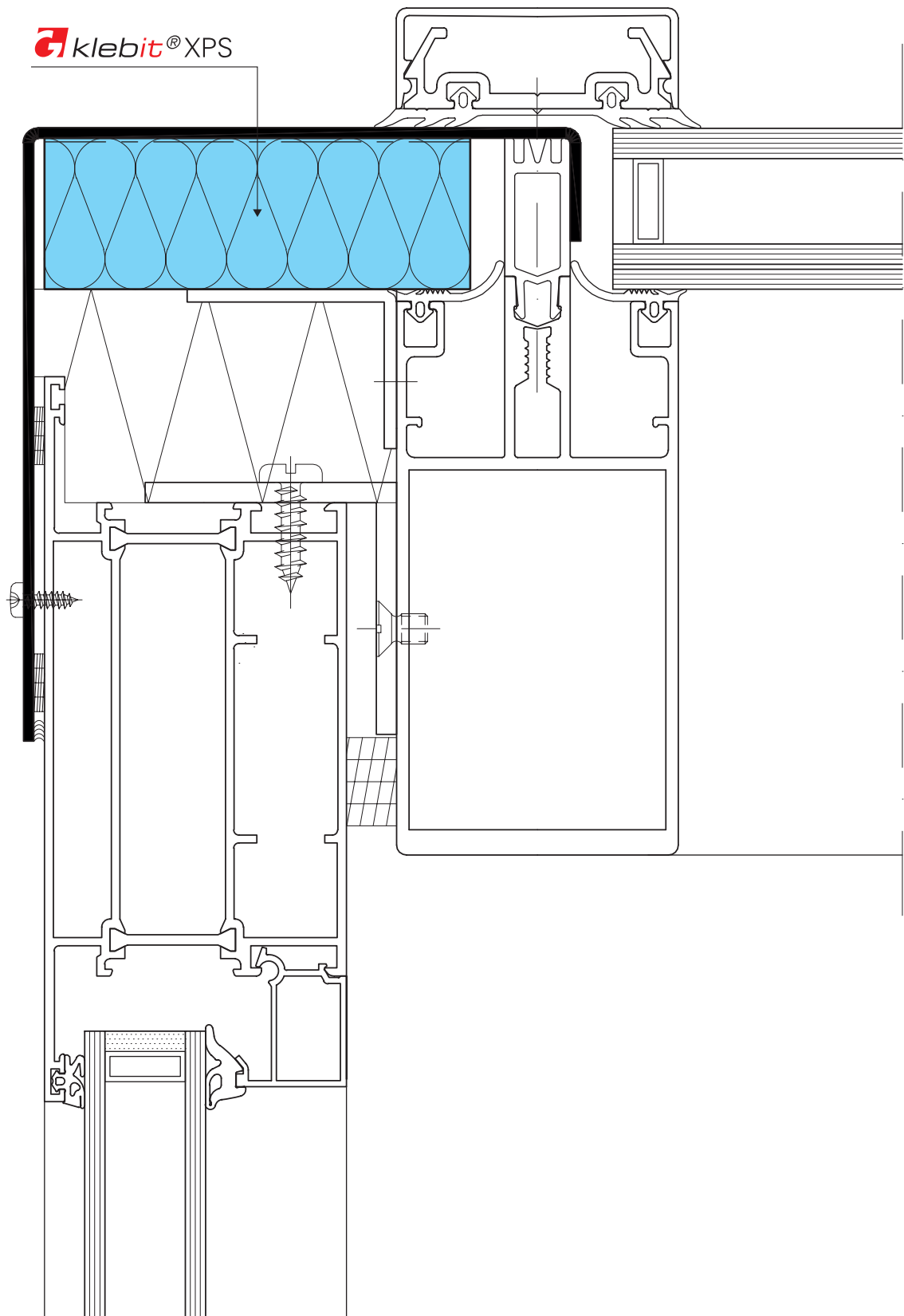

Einbaubeispiele

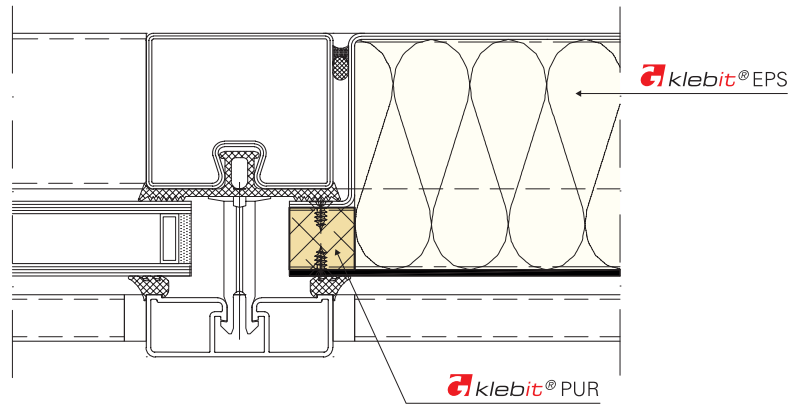
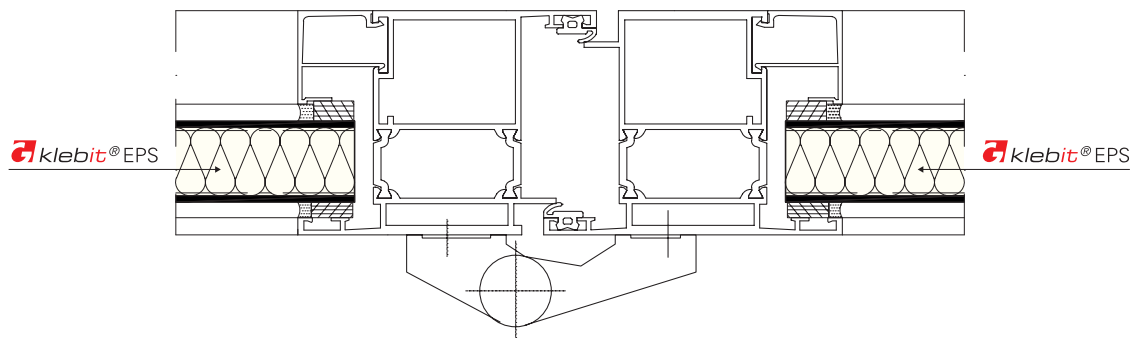

Detail Fusspunkt Glasoberlicht

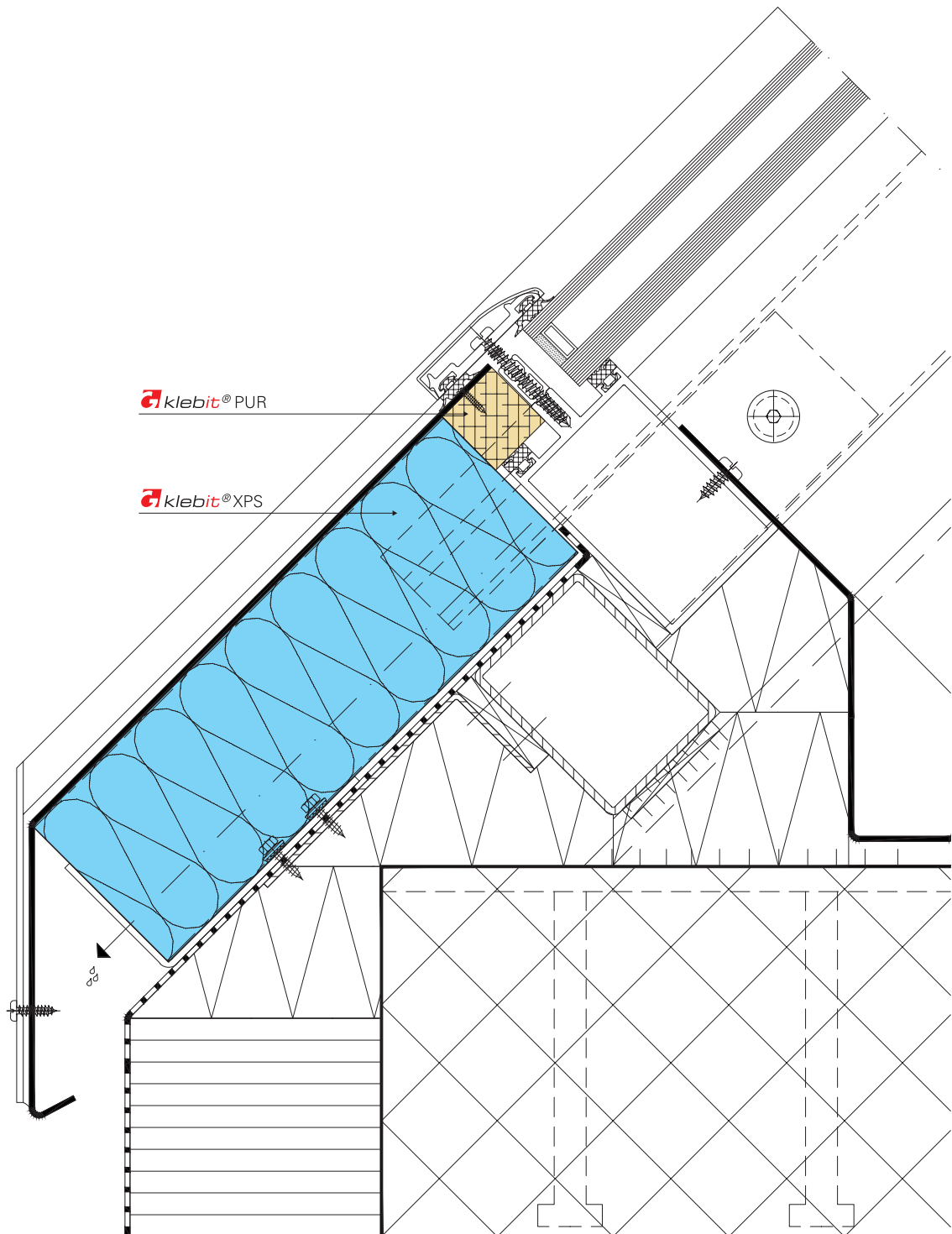

E



Traufkante Wintergarten

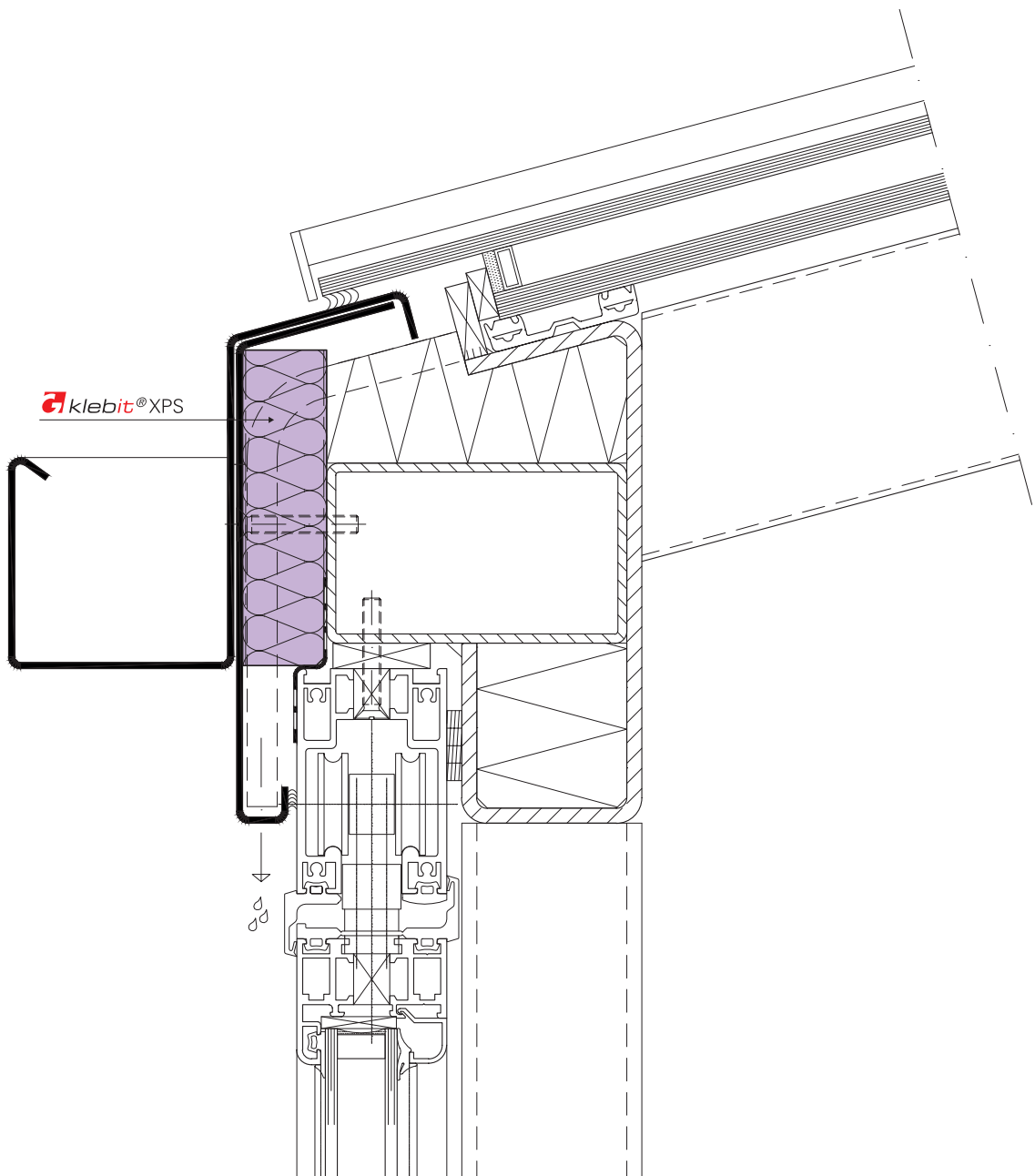

E

Traufkante Schrägverglasung

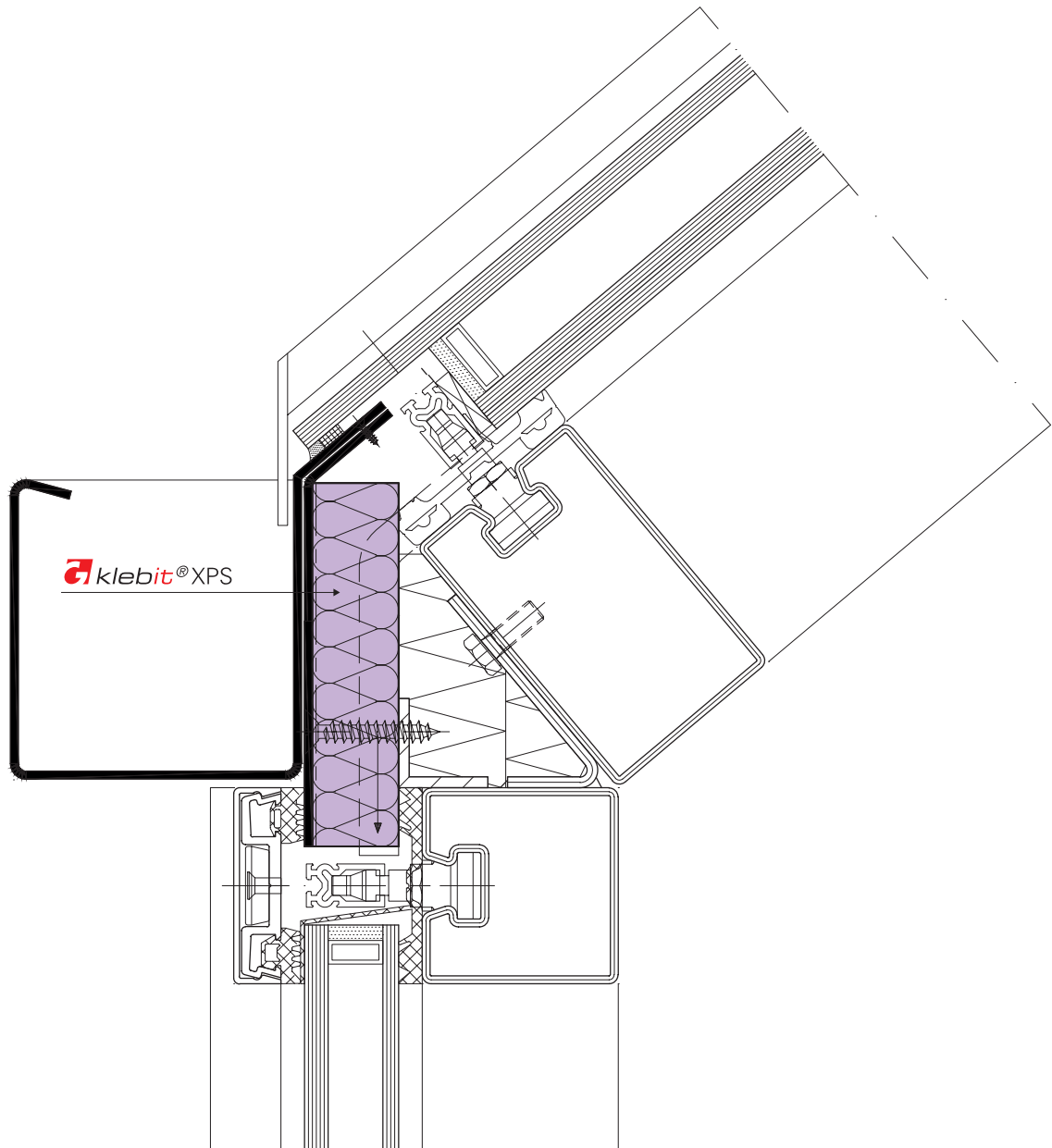

E



Traufkante Wintergarten

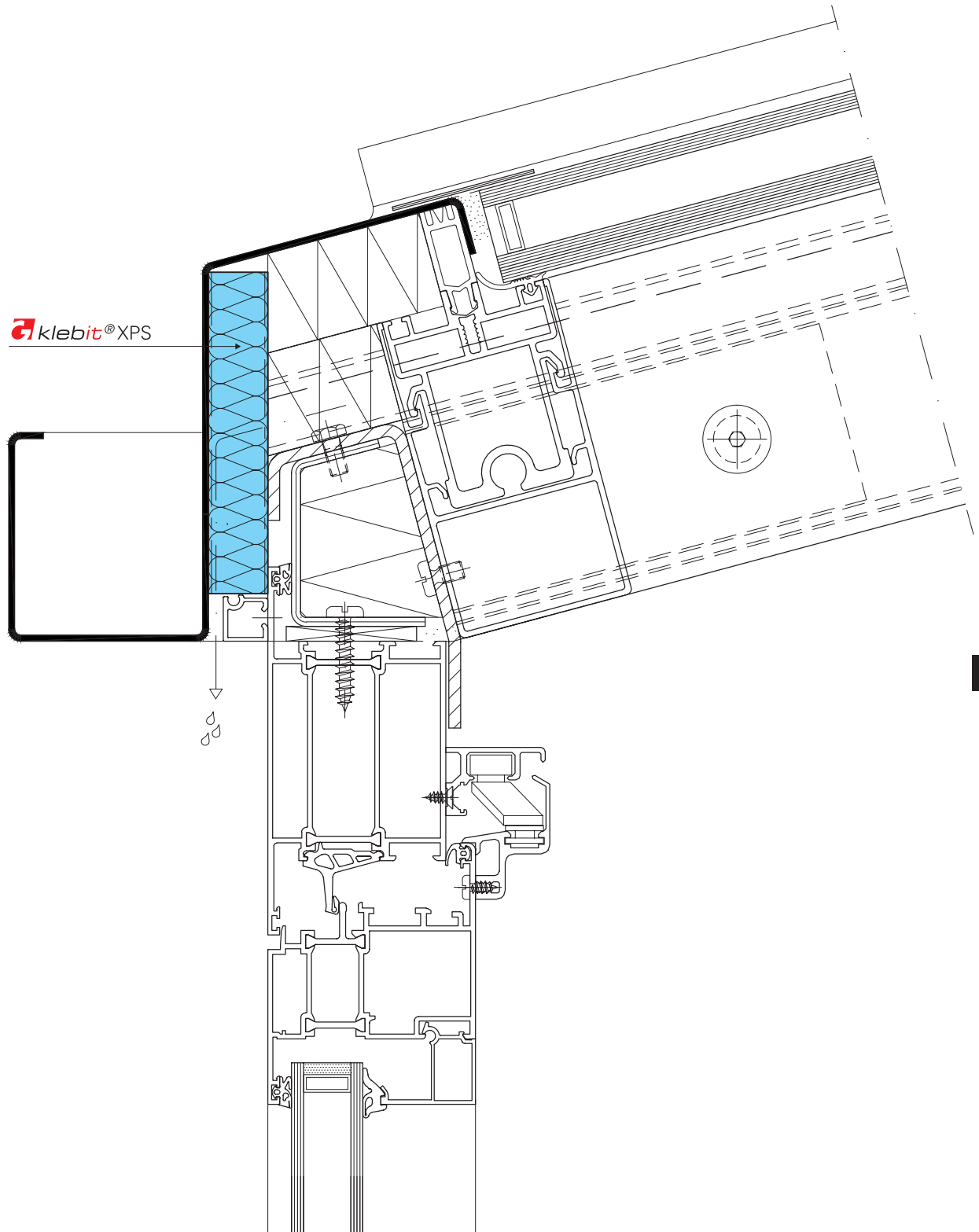

E



Detail Dachfirst

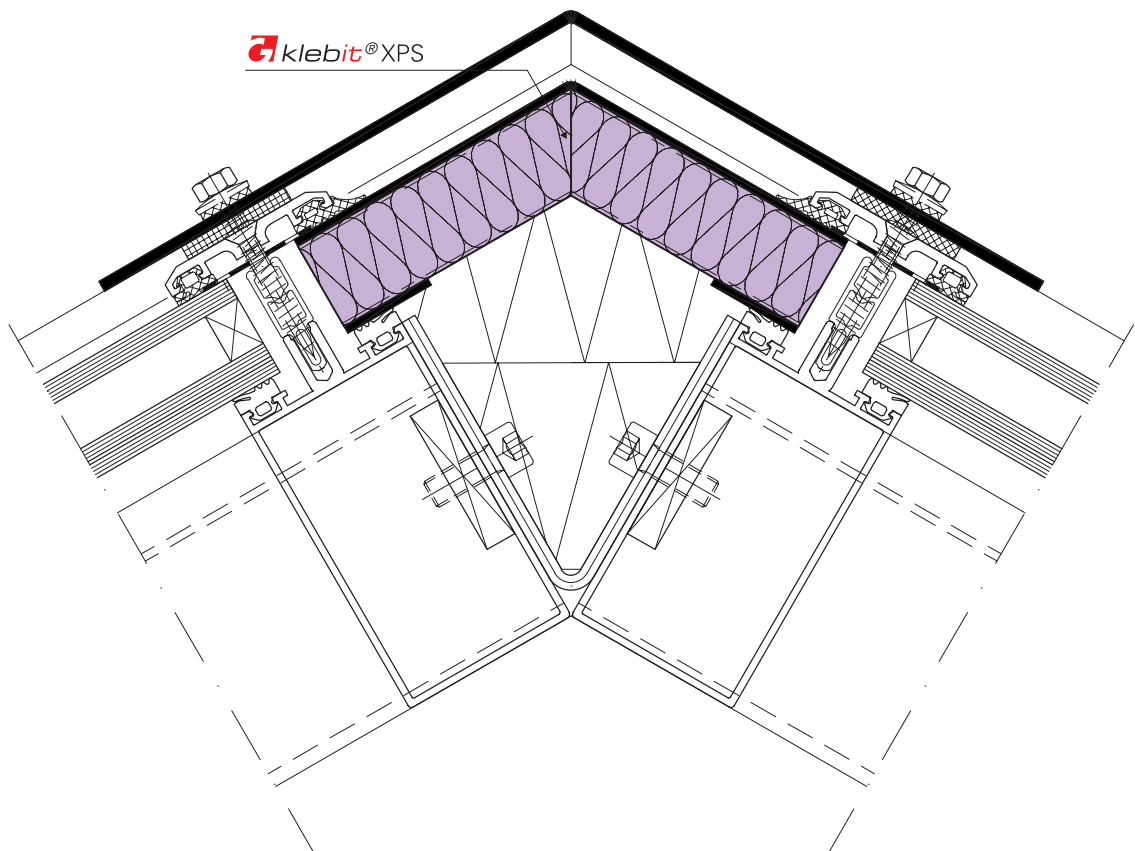

E



Innenecke von Schrägverglasung

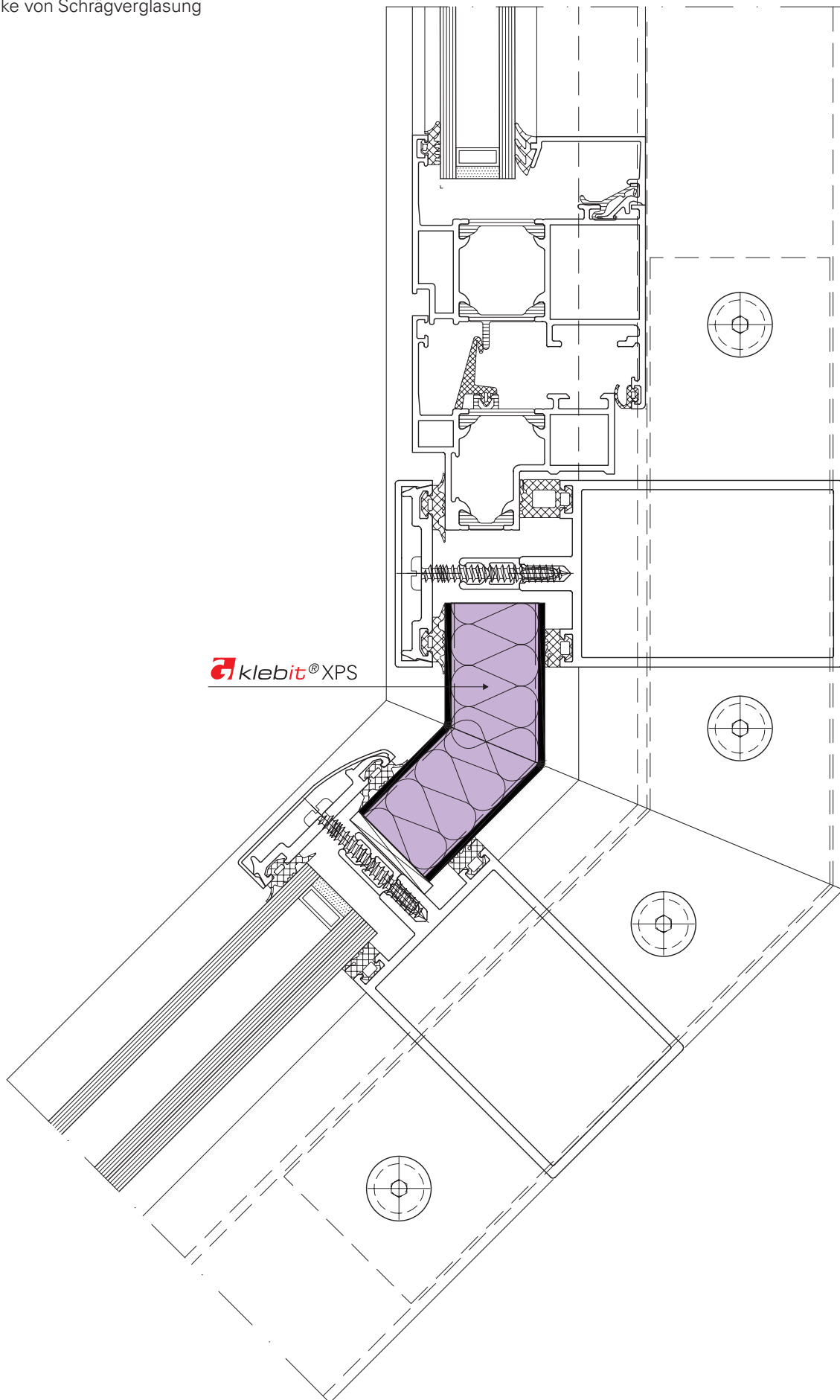

E

Traufkante Schrägverglasung

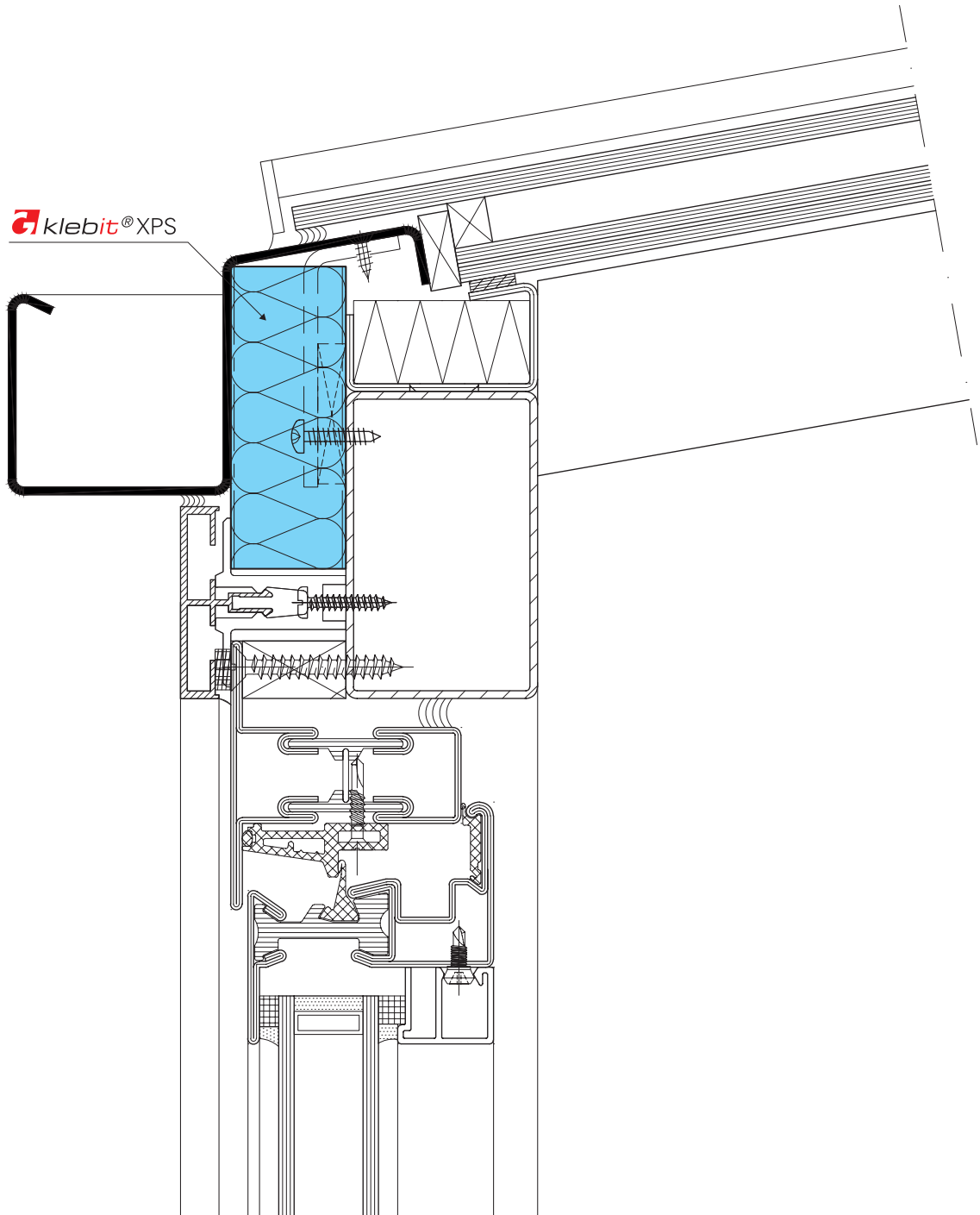

E



Detail Fusspunkt Fassade

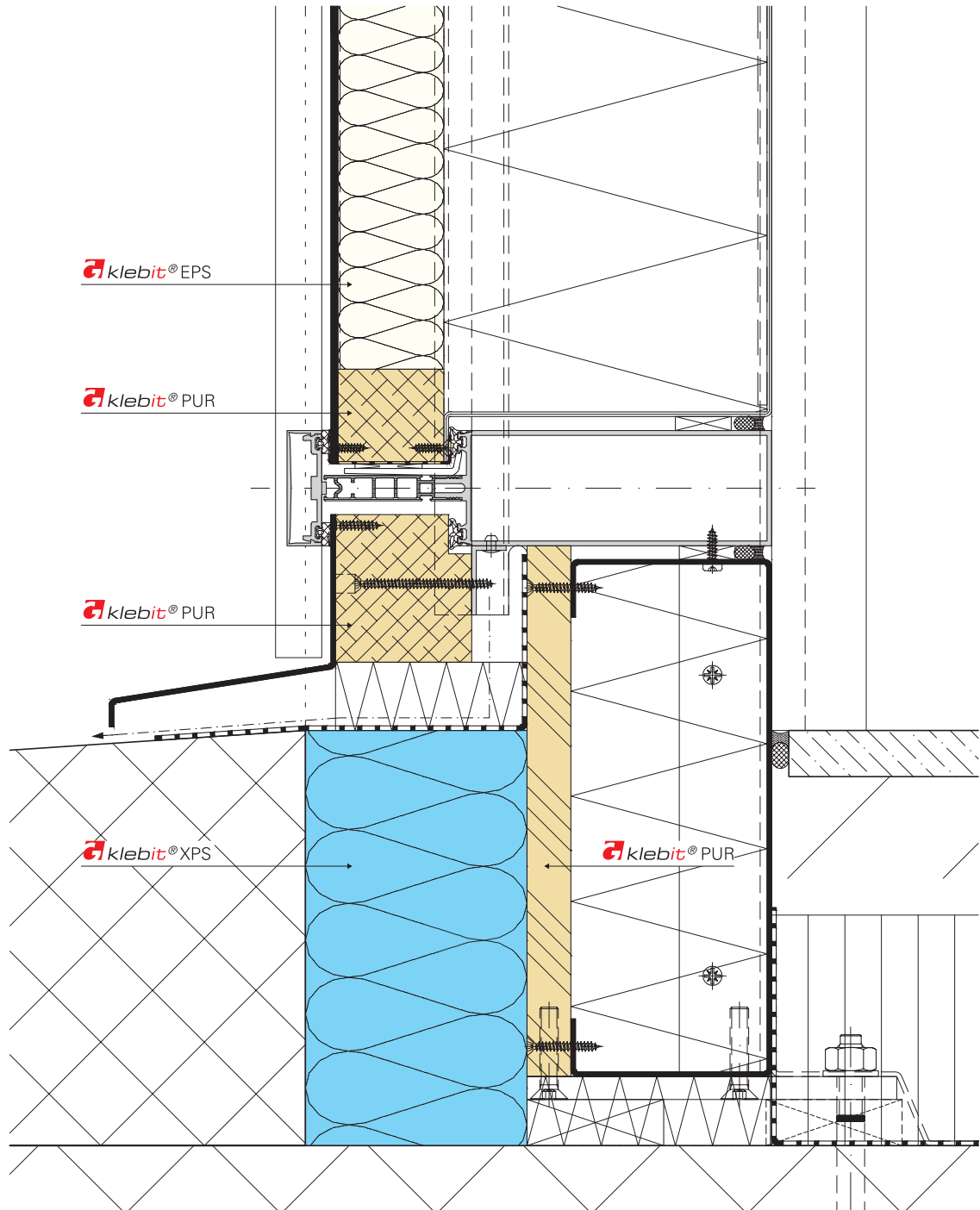

F



Detail Fusspunkt

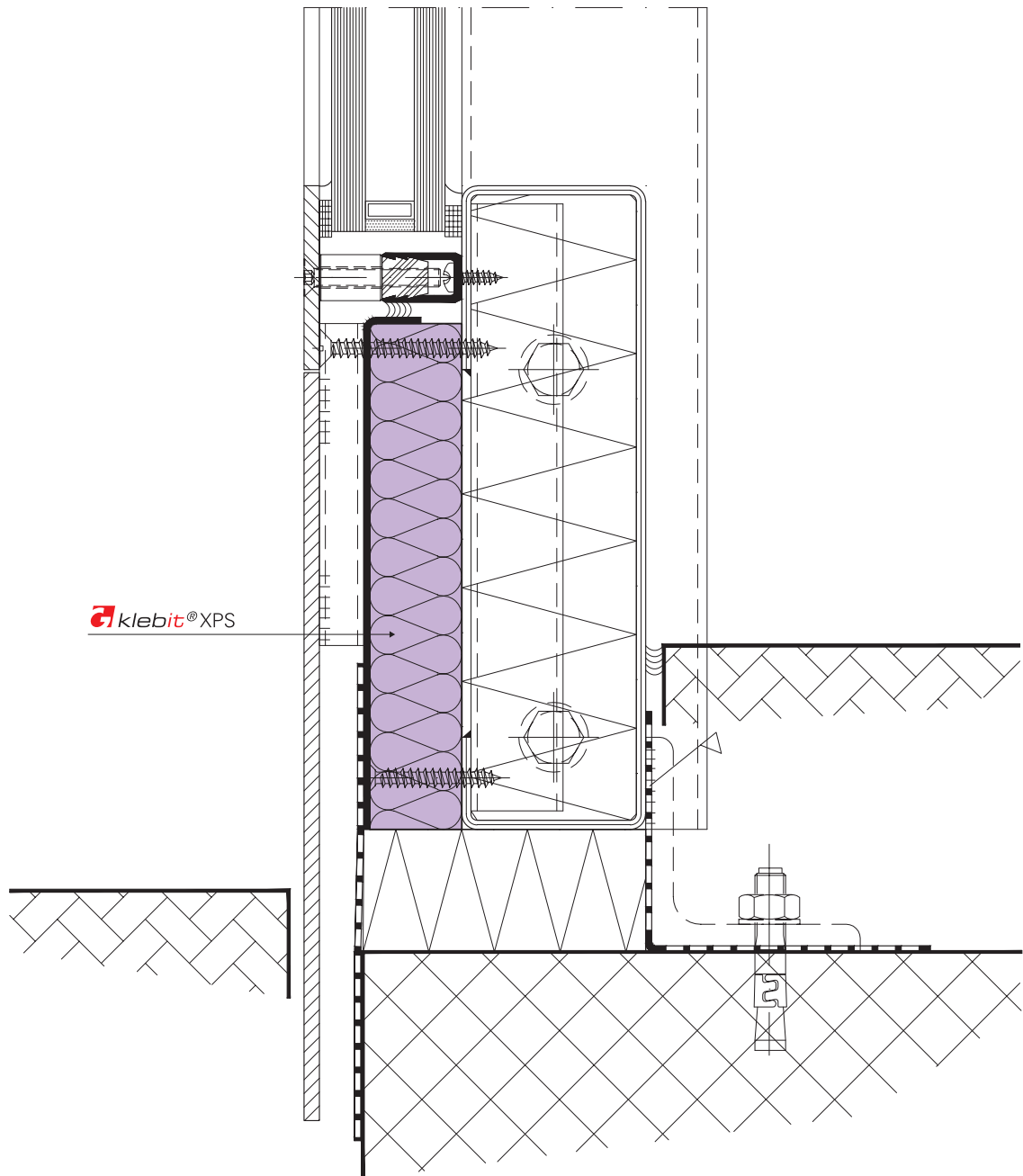

F



Detail Fusspunkt

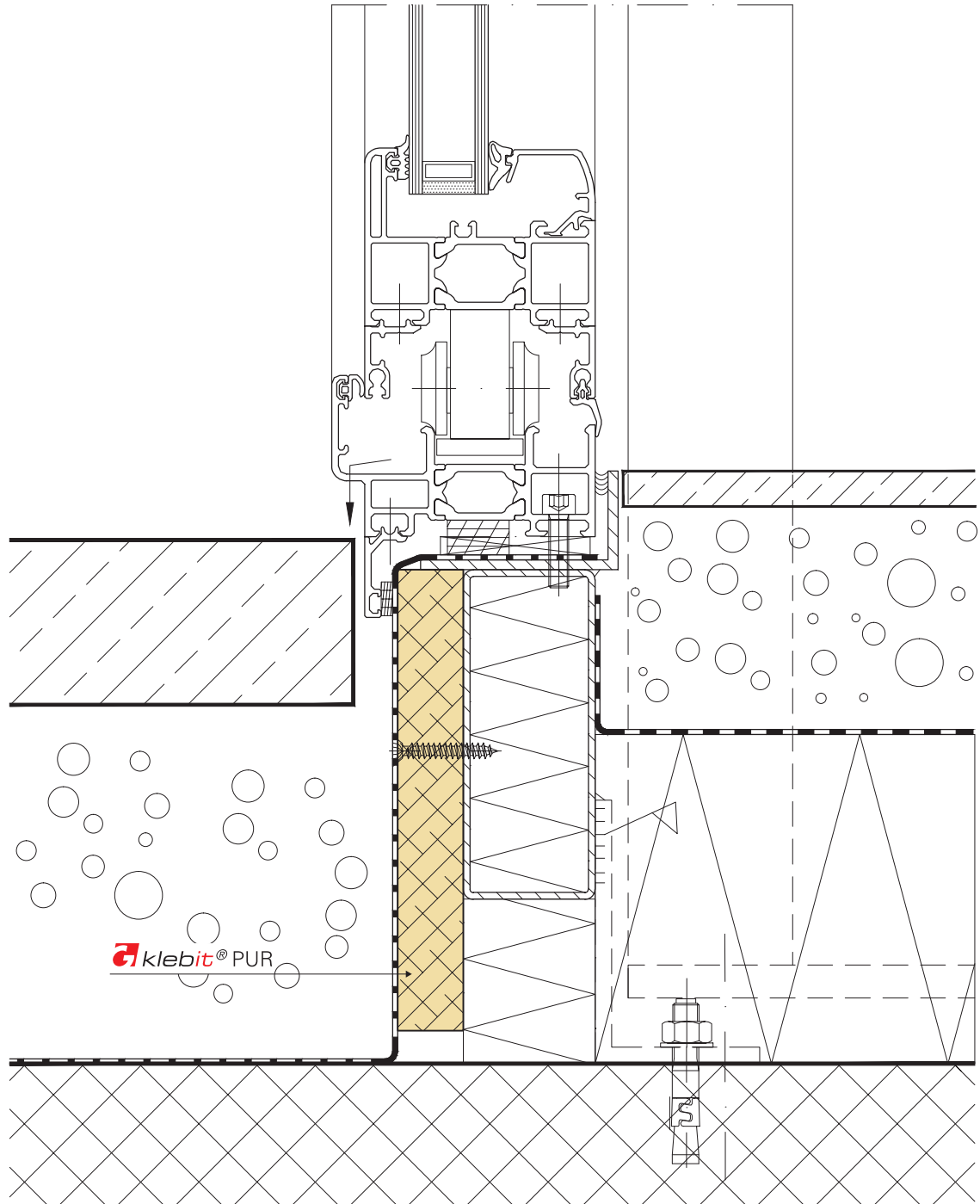

Detail Fusspunkt

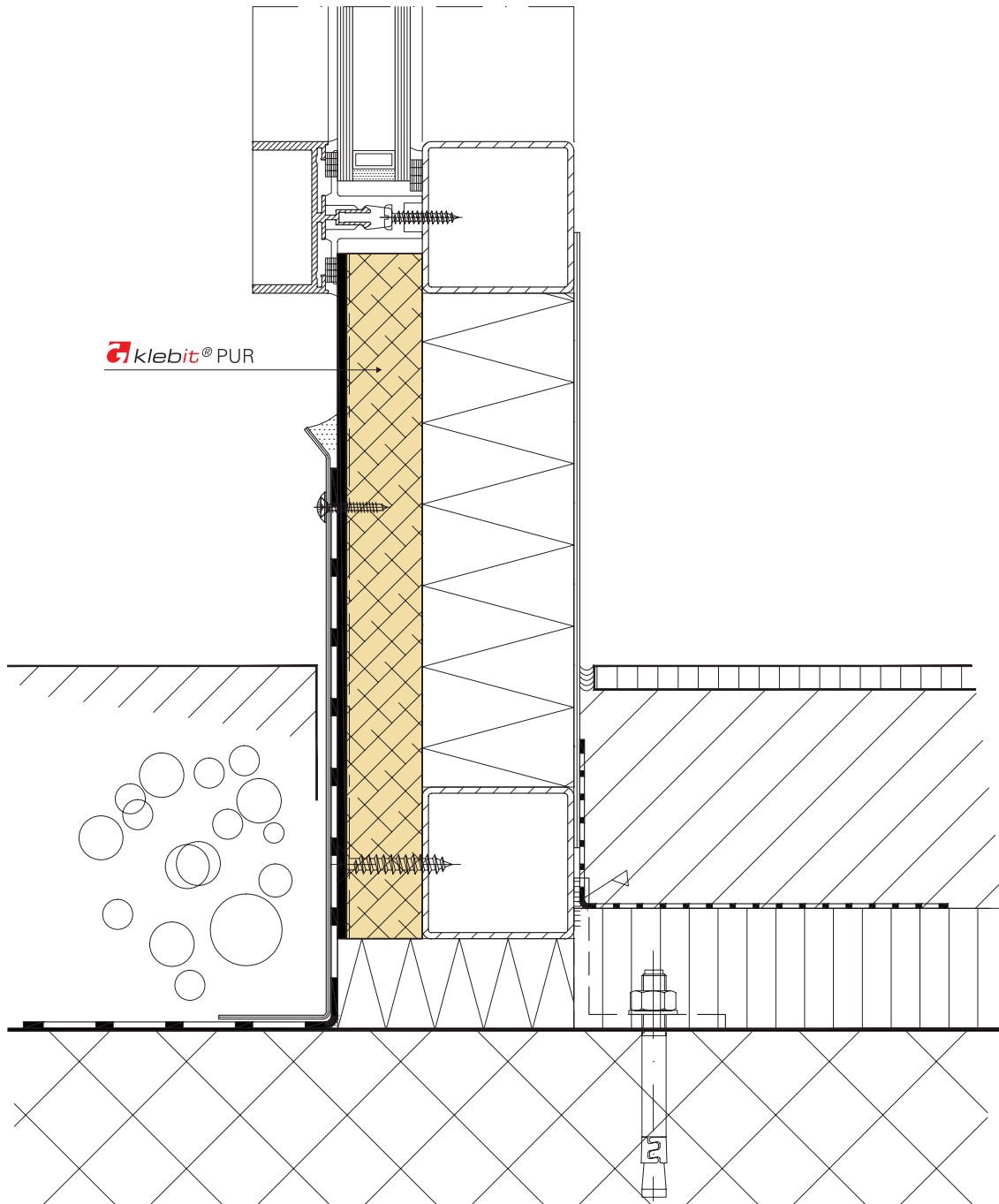

Detail Fusspunkt

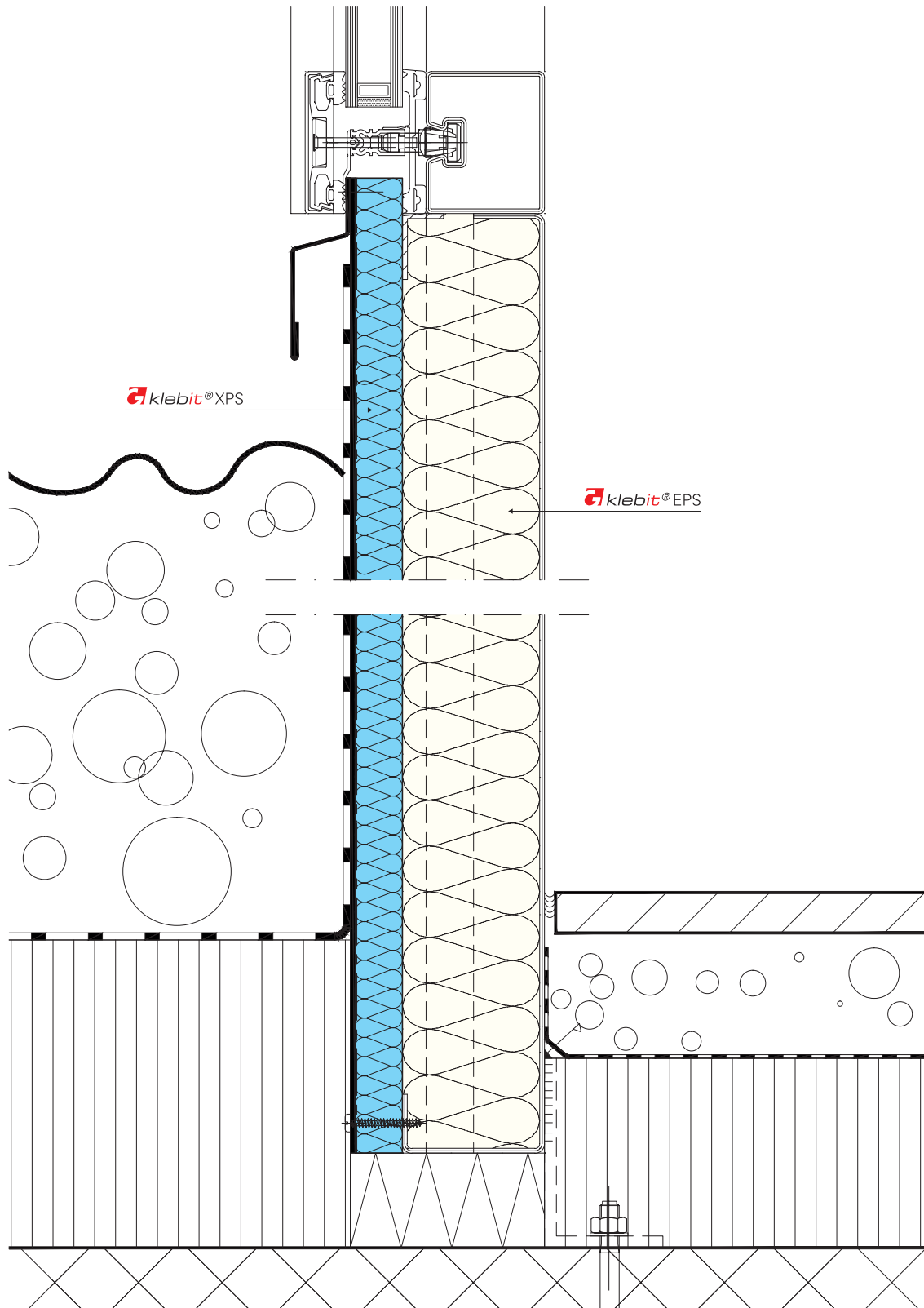

F



Detail Fusspunkt

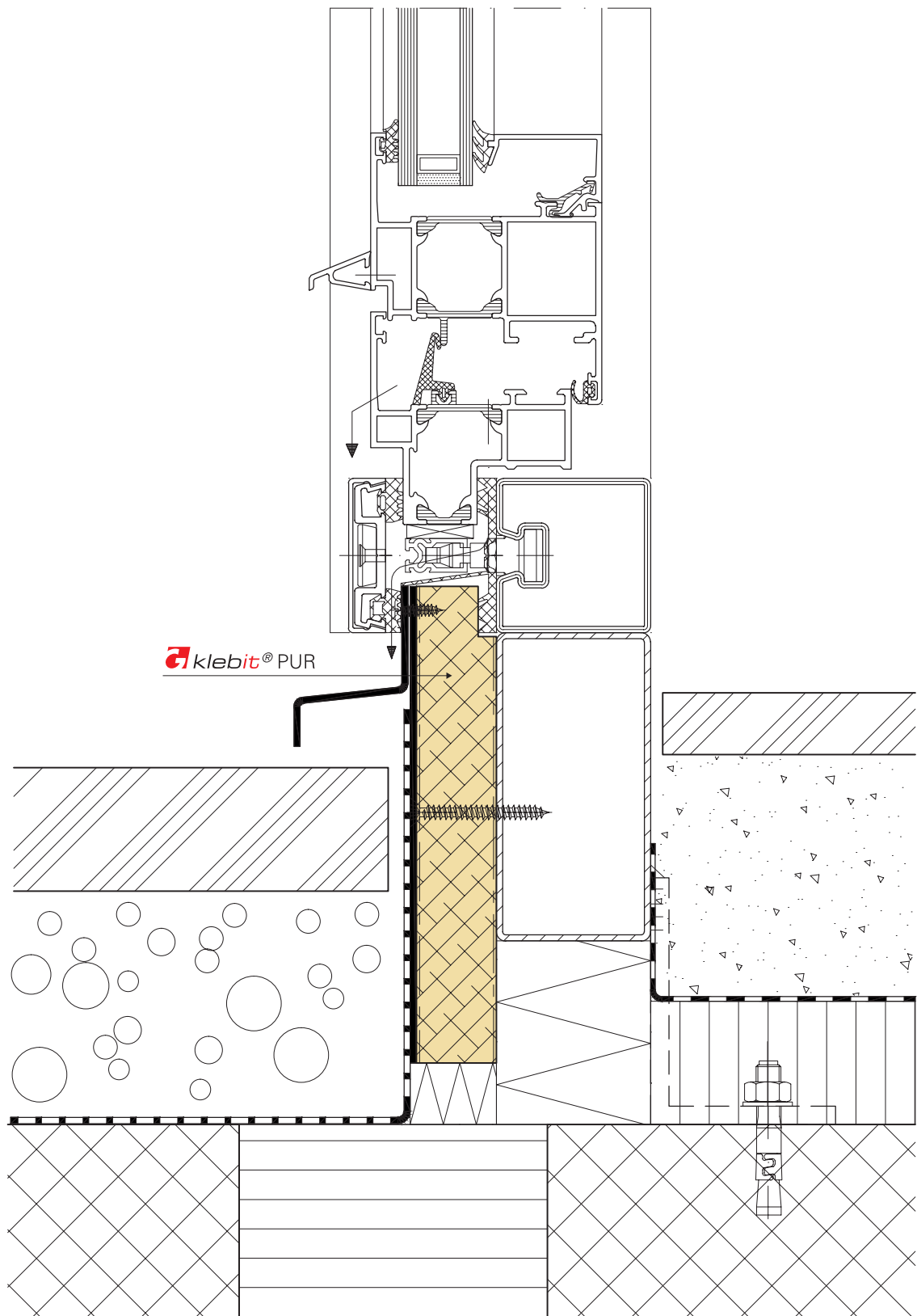

F



Detail Fusspunkt

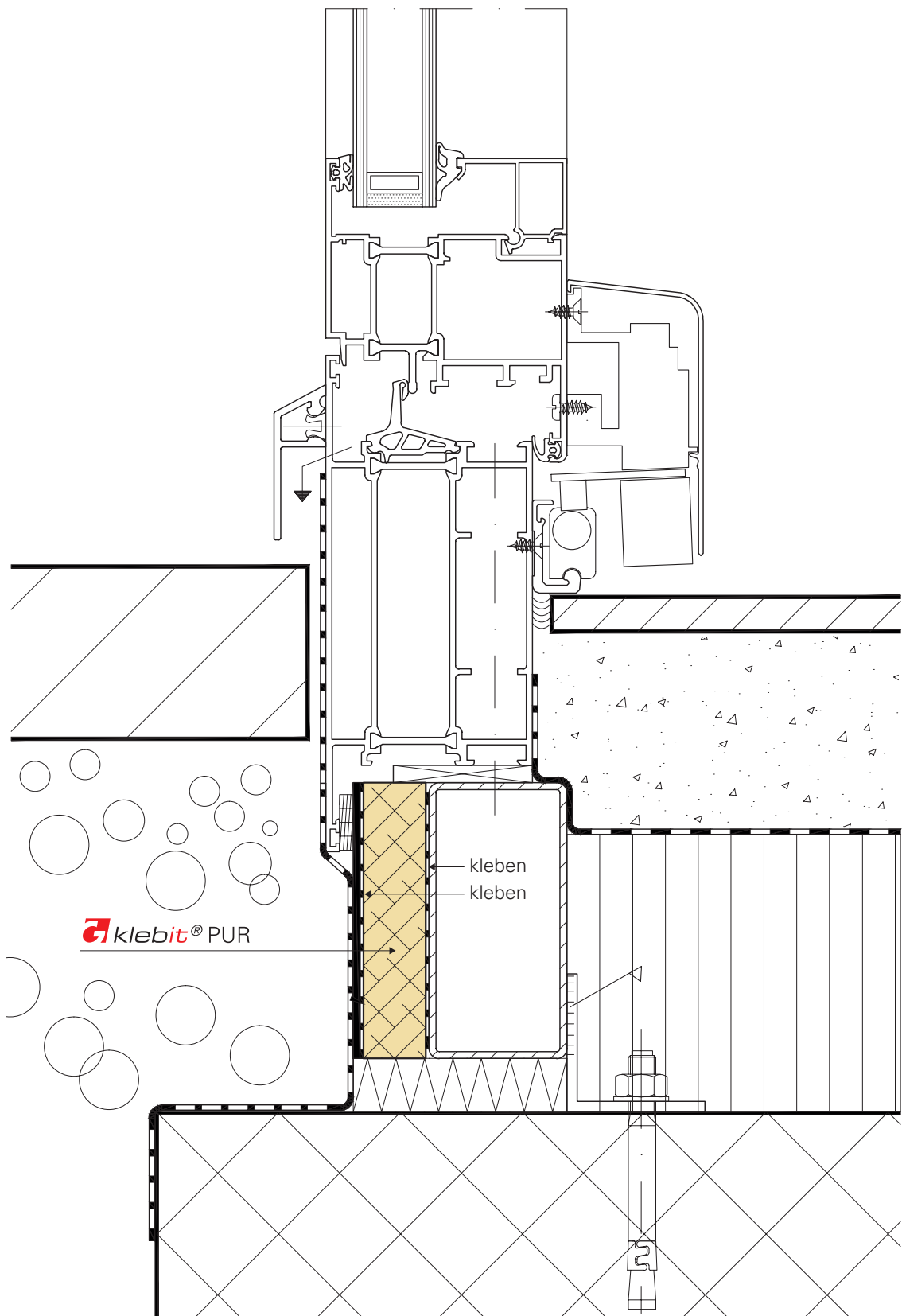

F

 klebit® PUR

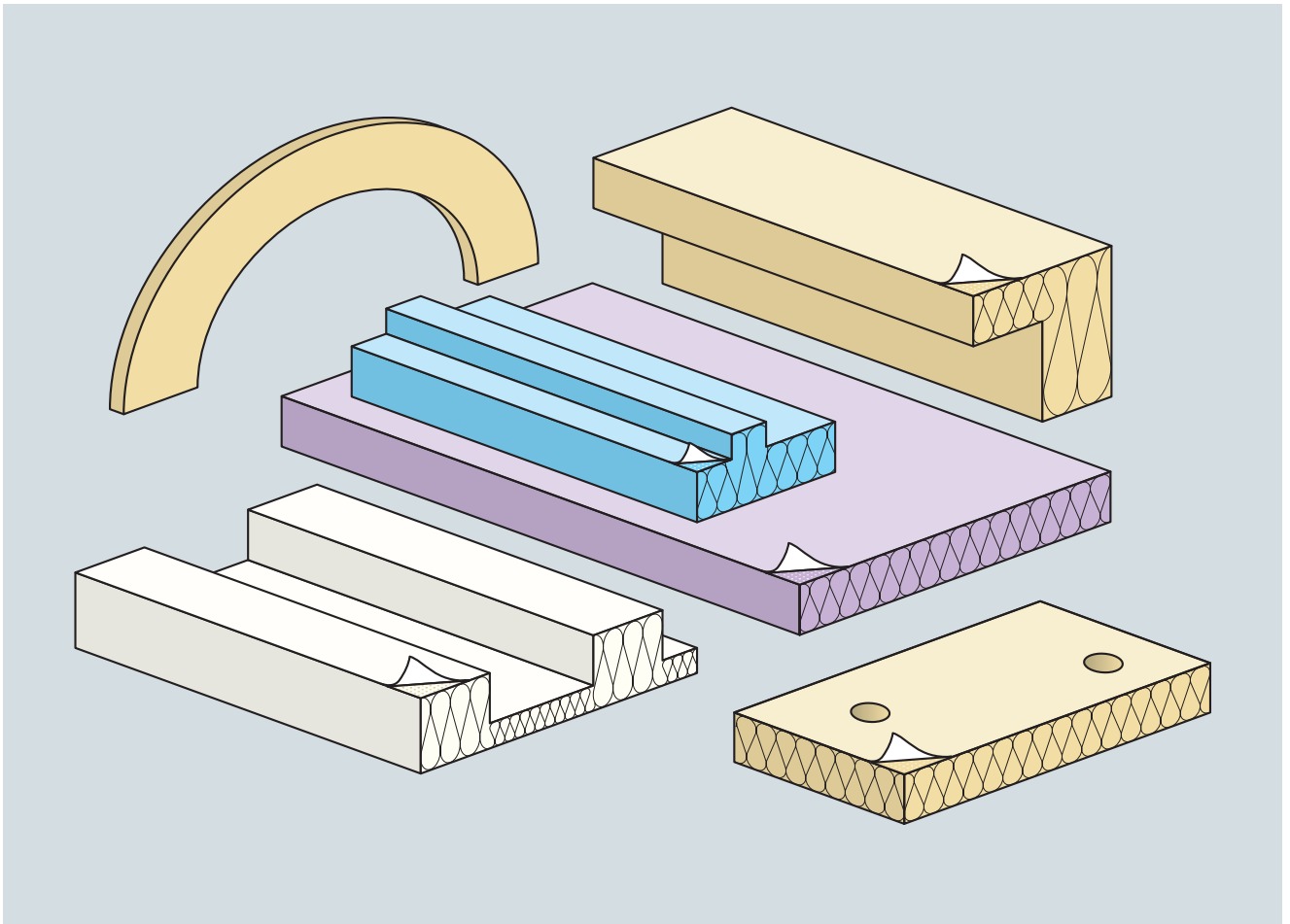
**Diverse Profilquerschnitte:**

- nach Ihrer Zeichnung
- Klebeflächen nach Bedarf

Wie sieht Ihr Formteil aus?**G**